

**TIMEGUARD®**

## Surface Mount IR DALI Presence Detectors

Model: PDSMDALI Surface Mount  
IR DALI Presence Detector

Model: PDSMCDALI Surface Mount  
IR DALI Corridor Presence Detector

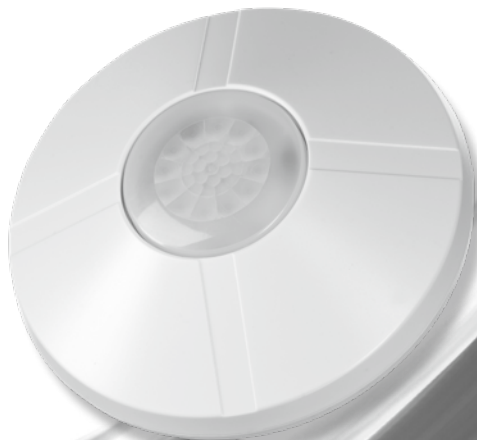

Installation & Operating Instructions

# 1. General Information

These instructions should be read carefully and retained for further reference and maintenance.

## 2. Safety

- Before installation or maintenance, ensure the mains supply to the PIR sensor is switched off and the circuit supply fuses are removed or the circuit breaker turned off.
- It is recommended that a qualified electrician is consulted or employed for the installation of this PIR sensor and that it is installed in accordance with the current IEE wiring and Building Regulations.

## 3. Technical Specifications

### General

- 230V AC 50 Hz
- This PIR is of Class II Construction and must not be earthed
- Detection angle: 360°
- Time ON adjustment: 10 sec, 30 sec, 1 min, 5 min, 10 min, 20 min, 30 min
- LUX Light level adjustment: 10, 100, 500, 1000 Lux
- CONSTANT LUX level adjustment: Constant light value of 300, 500, 1000 Lux
- STDBY (Standby) Time adjustment: OFF, 1m, 2m, 5m, 15m, 30m, ON
- Warm up period: 60 seconds
- DALI Group: Select channel 0 to E for grouping 0 to 14 to the connected load, Channel F = Broadcast to all the connected load
- Operating Temperature: -20°C to +40°C
- IP20 rated suitable for restricted internal applications
- CE compliant

### PDSMDALI

- Motion detection range: Up to a 9m diameter approx. at a 2.5m mounting height
- Dimensions (W x H x D): 140 x 140 x 51mm

### PDSMCDALI

- Motion detection range: Cross walk approx. 40m length. Straight approx. 16m width.
- Dimensions (W x H x D): 140 x 140 x 65.7mm

## 4. Selecting a Location

- Careful positioning of the sensor will be required to ensure optimum performance.
- The best all-around coverage is achieved with the unit mounted at the optimum height of 2.5 metres.
- The sensor is more sensitive to movement ACROSS its field of vision than to movement directly TOWARDS it. Therefore position the unit so that the sensor looks ACROSS the likely approach path.
- Reflective surfaces (i.e. white-painted walls) may cause false activation under extreme conditions.
- Avoid positioning the sensor where there are any sources of heat in the detection area (extractor fans, tumble dryer exhausts etc.) including opposite any other light sources.
- Install the sensor at least 3ft away from fluorescent and HVAC ducts, and at least 4ft away from incandescent fixtures and HVAC diffusers.

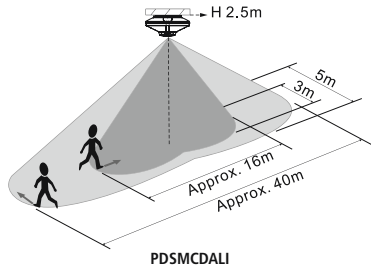
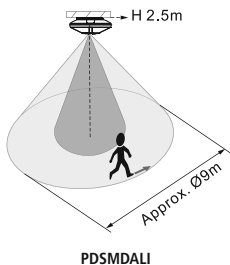

- **Please note the correct orientation of the sensor before installing, as per the image (right).**  
**Also see section 5, step 5.5 for details.**

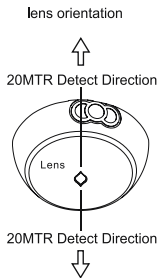

## 5. Installation

- 5.1 Ensure the mains supply is switched off and the circuit supply fuses are removed or the circuit breaker is turned off.
- 5.2 Make sure the power wiring comes from an external miniature circuit breaker for short circuit operation.
- 5.3 Remove the top cover of the sensor by twisting the top cover anti-clockwise, and then lift off the sensor.
- 5.4 Remove the back plate from the back of the sensor using the pull tab labelled 'open'.

- 5.5 Note the correct orientation of the sensor before installation, this is indicated by an arrow on the back plate, and sensor as shown.

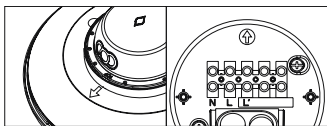

- 5.6 Mark the position of the mounting holes using the back plate as a template. Drill the mounting holes taking care to avoid any joists, electrical cables or water/gas pipes that may be hidden beneath the surface. Insert the rawl plugs into the holes.

- 5.7 Pass the 230V 50Hz mains supply and load cable through the cable entry point on the foam gasket and then the back plate, ensuring the grommet is used to maintain the IP rating of the PIR sensor.

- 5.8 Secure the foam gasket and back plate to the ceiling, using the correct mounting screws for the rawl plugs installed.

- 5.9 Terminate the cable into the terminal block ensuring correct polarity is observed and that all bare conductors are sleeved (see section 6. Connection Diagram).

- 5.10 It is recommended that the sensor body is fitted to the back plate and fixed to the ceiling as follows;

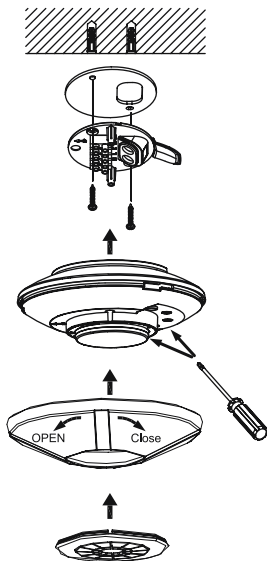

## 6. Connection Diagram

Connections are as follows;

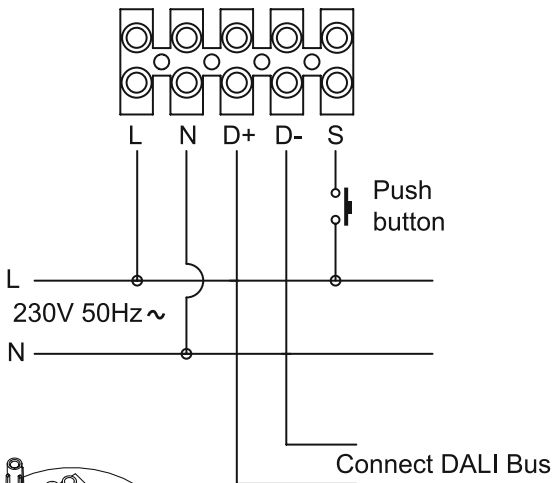

### NOTE:

Cross section of conductors: 1~2.5mm<sup>2</sup>

### 230V 50Hz Mains Supply

Live Supply (Brown or Red) to

L

Neutral Supply (Blue or Black) to

N

## 7. Adjustments

- The adjustments can be found beneath the top cover of the sensor. Check that the sensor is set to factory defaults, with the adjustments set as follows;

**TIME ON setting:** 10 seconds

**CONSTANT LUX setting:** 1000 Lux

**STDBY TIME:** OFF

**DALI Group:** F

- LUX:** Used to set the threshold light level to activate the sensor when it changes from day to night.
- CONSTANT LUX:** At the selected threshold light level the sensor will be activated. The sensor will automatically regulate the load to keep the light level at the selected threshold until it moves from day and over the threshold.
- TIME:** Used to select the desired time ON delay for when the sensor is activated.
- STDBY (Standby) TIME:** Used to select the time delay for standby (fixed at 20% of the brightness of the load).
- DALI Group:** Used to select the channel 0 to E for grouping 0-14 of the connected load, or Channel F to broadcast to all of the connected loads.
- Push Button Function (S Terminal):** An external push button can be installed for manual light control (see section 6. Connection Diagram). Press the button once to turn the load ON, the time ON delay will be adjusting to the TIME adjustment. Press the button once again to turn the load OFF, the time OFF delay will also activate according to the TIME adjustment. Hold the button down to dim (up or down) the load, and release the button and the current brightness value will be retained. Hold the button down a second time to dim the load the reverse way.

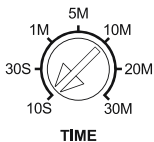
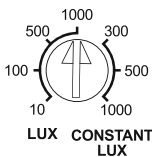

## 8. Initial Set-up and Operation

- Switch the power to the detector on, the sensor LED indicator and load will turn ON for a warm-up period of approximately 60 seconds.
- Once the warm-up period is complete, walk in front of the detector until the load turns ON. This checks the operation of the detector and field of view.
- When in Test Mode (when using the Timeguard IRRDALI remote control), the sensor LED indicator and load will turn ON for 3 seconds when each movement is detected. Without the IRRDALI remote control, the sensor LED indicator will turn on the load for the duration as set on the TIME setting (minimum is 10 seconds).
- Walk around the sensor to establish the detection area.
- Turn the TIME and LUX control settings to the desired positions.
- The detector is now in Auto Mode and will operate according to the pre-set TIME and LUX light level adjustments. Once activated, the sensor LED indicator and load will remain ON until it times out.



## 9. Lens Mask

- The supplied lens mask can be used to reduce the sensor coverage, preventing detection in unwanted areas.
- Cut the lens mask either horizontally or vertically until the desired area of detection is obtained.
- For your information, the centre section of the lens mask covers short range detection, and the outer edge of the lens mask covers long range.
- Push the lens mask into the slot around the sensor head. The position can be adjusted by sliding it around the slot as follows;

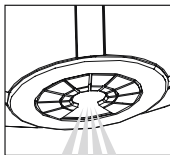
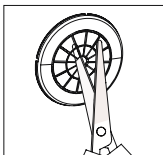

PDFMDALI

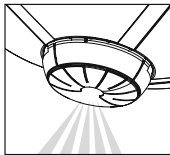
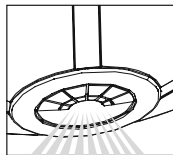

PDFMCDALI

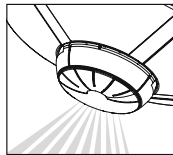

## 10. Troubleshooting

### Problem

The sensor will not function at all/Load will not come ON

### Solution

Check the wiring to make sure that you have the correct AC power and DALI power at the sensor.

Check the wiring from the sensor to the source of power to make sure you have wired the sensor correctly.

Check the LUX adjustment to see if it is set at your desired level.

Detector clicks but does not work

Check the load is operational.

Load goes ON and OFF too quickly

Ensure light and heat are not being deflected onto the detector. Check for white or reflective surfaces that may be causing the problem.

Note the detector is more sensitive in cold weather.

Make sure the sensor isn't installed close to an air conditioner.

Load stays ON

Check the wiring to ensure the load isn't wired directly to the supply.

Adjust the time to minimum, and ensure the sensor is firmly fixed to a fixed solid object with no moving objects in the field of view.

Ensure the detector is not being activated by stray moving heat sources such as heating outlets.

## 3 Year Guarantee

In the unlikely event of this product becoming faulty due to defective material or manufacture within 3 years of the date of purchase, please return it to your supplier in the first year with proof of purchase and it will be replaced free of charge.

For years 2 and 3 or any difficulty in the first year, telephone the helpline on 020 8450 0515.

Note: A proof of purchase is required in all cases. For all eligible replacements (where agreed by Timeguard) the customer is responsible for all shipping/postage charges outside of the UK. All shipping costs are to be paid in advance before a replacement is sent.



If you experience problems, do not immediately return the unit to the store. Telephone the Timeguard Customer Helpline:

HELPLINE

**020 8450 0515**

or email [helpline@timeguard.com](mailto:helpline@timeguard.com)

Qualified Customer Support Coordinators will be online to assist in resolving your query.



A **theben** Group Company

For a product brochure please contact:

**Timeguard Limited.**

Victory Park, 400 Edgware Road,

London NW2 6ND

Sales Office: 020 8452 1112

or email [csc@timeguard.com](mailto:csc@timeguard.com)

**[www.timeguard.com](http://www.timeguard.com)**