

TIMEGUARD®

18W Round LED Slimline Emergency Light with Microwave Sensor

Model: LEDMRQ18WHEMMS



Installation & Operating Instructions

1. General Information

These instructions should be read carefully and retained for further reference and maintenance.

2. Safety

- Before installation or maintenance, ensure the mains supply to the luminaire is switched off and the circuit supply fuses are removed or the circuit breaker turned off.
- It is recommended that a qualified electrician is consulted or used for the installation of this luminaire and install in accordance with the current IEE wiring and Building Regulations.
- Check that the total load on the circuit including when this luminaire is fitted does not exceed the rating of the circuit cable, fuse or circuit breaker.
- Do not dismantle the lamp or unscrew the LED board, this will affect the heat distribution and reduce the lifespan of the LED luminaire.
- Never clean with a damp cloth whilst the luminaire is switched ON.

3. Technical Specifications

- 230V AC 50 Hz
- This luminaire is of class II construction and must not be earthed
- 18W LED Non-replaceable lamp
- Energy efficiency: Class A
- Energy Usage: 18Kwh/1000H
- Lumen Output: 1680lm
- Emergency Output: 50% (752lm)
- Emergency duration: > 3 hours
- Colour Temperature: 4000K
- Operating Temperature: 0°C to +40°C
- Battery charge time: 24 hours (Non-replaceable rechargeable)
- Power Status Indicator: Green LED when mains power is ON.
- Detection Angle: 360° ceiling, 180° wall mounted
- Detection Range Adjustment: 1m to 8m (at a mounting height of 2.5m)
- Time On Adjustment: 5 seconds to 30minutes
- Lux Range Adjustment: 5 to 50 lux
- IP20 Rated suitable for internal use only
- CE Compliant
- Dimensions: 285mm diameter x 56mm
- Mounting Centres: 40mm

4. Installation

Note: A permanent supply live is required to charge the internal battery, which is used in emergency mode.

- 4.1 Ensure the mains supply is switched off and the circuit supply fuses are removed or the circuit breaker turned off.
- 4.2 Rotate the back plate anti-clockwise to unscrew, lift the back plate away from the luminaire. Carefully disconnect the 2 way plug by holding down the locking bar on one half, at the same time grip the opposite side and pull apart. This will disconnect the back plate completely.
- 4.3 Using the back plate as a template, mark the position of the mounting holes on the wall or ceiling.
- 4.4 Drill the holes for the rawl plugs ensuring not to infringe with any gas/water pipes or electrical cables that may be hidden below the surface. Insert the rawl plugs into the holes.
- 4.5 Pass the 230V AC 50Hz mains supply cable through the back plate.
- 4.6 Fix the back plate to the ceiling or wall using the correct screws for the rawl plugs installed.
- 4.7 Terminate the supply cable into the spring clamp terminal block (See section 5. Connection Diagram) ensuring correct polarity is observed and that all bare conductors are sleeved.
- 4.8 Re-connect the 2 way plug by pushing the plug and socket together until they lock. **DO NOT FORCE. THE PLUG AND SOCKET WILL ONLY FIT TOGETHER ONE WAY AROUND.**
- 4.9 Reposition the luminaire over the back plate, rotate the luminaire clockwise to screw into place and secure.

4

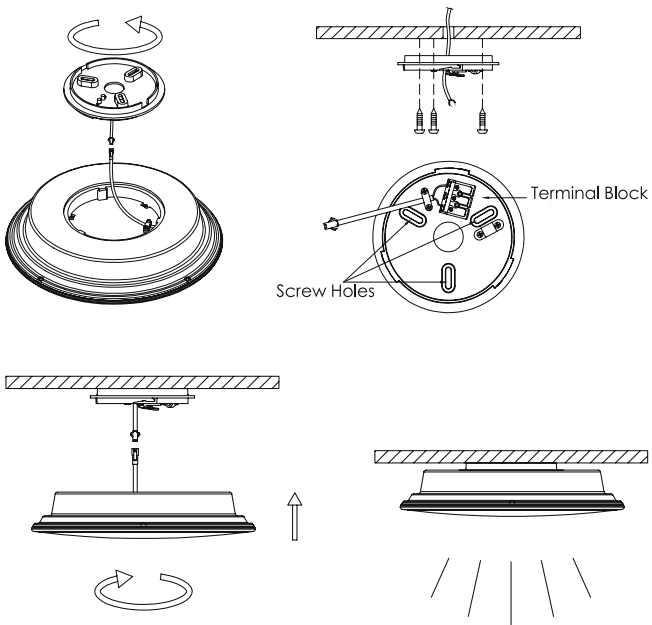

5. Connection Diagram

- This luminaire uses a spring clamp terminal for connection as shown;

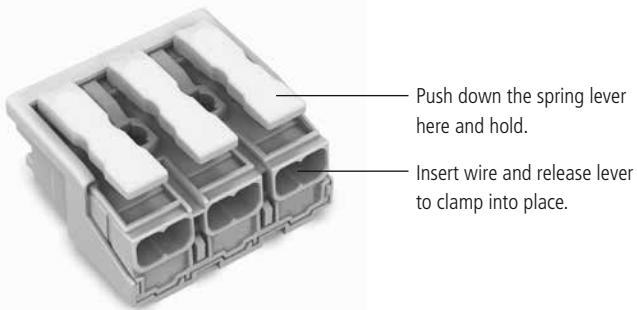

Note: You will require a Permanent Live to charge the internal battery which is used in emergency mode. A switch can also be installed (breaking the Switch Live connection) in order to turn the luminaire ON & OFF for normal operation;

- Connect the 230V AC 50Hz mains supply cable to the spring clamp terminal as follows:

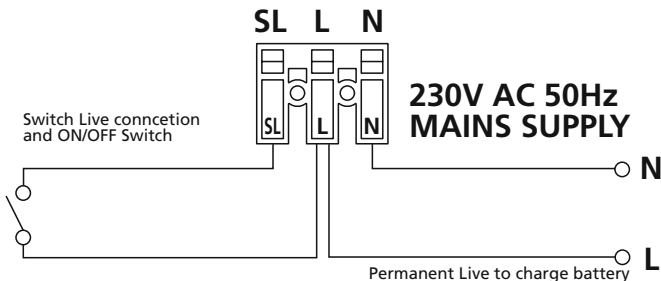

5

230V 50Hz Mains Supply

Live Supply (Brown or Red) to	L
Neutral Supply (Blue or Black) to	N

- Use the provided cable clamp to secure the mains supply cable to the back plate.

6. Setting Up & Testing

Walk Test

- The adjustable DIP switches are factory set to "Walk Test" mode i.e. Detection Area set to '100%', the Hold Time set to the minimum of '5 seconds' and the Daylight Sensor set to 'Disable'.
- Turn the power to the unit ON. The luminaire will immediately turn ON as the unit goes through its 'warm-up' period. After approximately 10 seconds the light will extinguish. This indicates the luminaire is wired correctly and the unit is in "Walk Test" mode. The green LED indicator will illuminate when mains power is present.
- Try to remain out of the area of detection during the 'warm-up' period.

- The luminaire will now operate during daytime as well as at night, turning ON for approx. 5 seconds each time the sensor is activated. This allows testing to be carried out to establish whether the microwave sensor is covering the required area.
- Walk around the luminaire to establish the detection area.
- The microwave sensor will detect within an 8m diameter (approximately) from the centre of the luminaire location when mounted at a 2.5m height.
- As you cross a detection "zone" the luminaire will turn ON. Now stand still until the luminaire extinguishes (this should take approx. 5 seconds).
- Start moving again after 2 seconds. As you cross each "zone" the luminaire will turn ON.
- Repeat the above, walking at various distances and angles to the luminaire. This will help you to confirm the detection pattern.

Setting Up for Automatic Operation

- When walk tests are complete, the luminaire can be adjusted for automatic operation.
- Ensure the power to the luminaire is switched OFF, and then disconnect the luminaire from the back plate using step 4.2, as detailed in section 4. Installation.

Note: if the internal battery is charged the luminaire will turn ON whilst you adjust it, running at 50% output for up to 3 hours (see section 7. Emergency Mode & Internal Battery for further details).

- To access the adjustable DIP switches, undo and remove the 4 fixing screws that hold the bezel and plastic lens cover to the base of the luminaire. The DIP switches are located on the LED board.

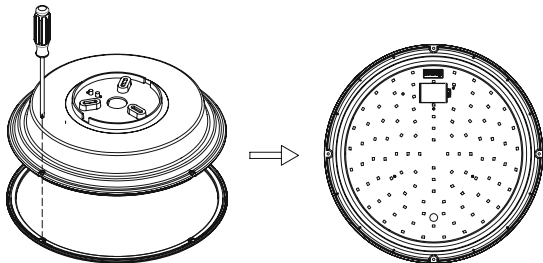

- The 'Detection Area' setting controls determines the range of detection.

	1	2	3	
	ON	ON	ON	100%
	-	ON	ON	75%
	ON	-	ON	50%
	-	-	ON	25%
	-	-	-	10%

Adjust the range of detection by moving the positions of the DIP switches as advised below (this information is also printed on the LED Board above the DIP switches);

Note: Up is ON, Down is OFF.

100% DIP switches 1, 2, 3 ON

75% DIP switch 1 OFF – DIP switches 2, 3 ON

50% DIP switch 1 ON – DIP switch 2 OFF – DIP switch 3 ON

25% DIP switches 1, 2 OFF – DIP switch 3 ON

10% DIP switches 1, 2, 3 OFF

- The 'Hold Time' setting controls how long the luminaire remains ON following activation and after all motion ceases.

	4	5	6	
	ON	ON	ON	5 s
	-	ON	ON	30s
	ON	-	ON	90s
	-	-	ON	3min
	ON	ON	-	20min
-	-	-	30min	

Adjust the ON time by moving the positions of the DIP switches as advised below;

5 seconds DIP switches 4, 5, 6 ON

30 seconds DIP switch 4 OFF – DIP switches 5, 6 ON

90 seconds DIP switch 4 ON – DIP switch 5 OFF – DIP switch 6 ON

3 minutes DIP switches 4, 5 OFF – DIP switch 6 ON

20 minutes DIP switches 4, 5 ON – DIP switch 6 OFF

30 minutes DIP switches 4, 5, 6 OFF

- The 'Daylight Sensor' setting determines the level of darkness required for the luminaire to start operating.

ON 	7	8	9	
	ON	ON	ON	Disable
	ON	ON	-	50LUX
	ON	-	ON	30LUX
	-	ON	ON	10LUX
	-	-	-	5LUX

Adjust the LUX level by moving the positions of the DIP switches as advised below;

Note: 50 Lux and 30 Lux is twilight operation, 10 Lux and 5 Lux is darkness operation only. 'Disable' means the luminaire will switch ON when motion is detected regardless of the ambient light level.

Disable DIP switches 7, 8, 9 ON

50 Lux DIP switches 7, 8 ON – DIP switch 9 OFF

30 Lux DIP switch 7 ON – DIP switch 8 OFF – DIP switch 9 ON

10 Lux DIP switch 7 OFF – DIP switches 8, 9 ON

5 Lux DIP switches 7, 8, 9 OFF

- Once you have adjusted the luminaire to the desired settings, fit the plastic lens cover back in to place followed by the bezel.
- Secure them both using the 4 fixing screws previously removed.
- Re-connect the luminaire to the back plate using steps 4.8 & 4.9, as detailed in section 4. Installation.
- Switch the power to the luminaire ON.

7. Emergency Mode & Internal Battery

- When power is switched ON, the green LED indicator will immediately illuminate confirming mains power is present, and the internal battery will begin to charge. The luminaire will also go through its 'warm up' period as detailed in section 6. Setting Up & Testing.

Note: the internal battery will take 24 hours to fully charge.

- When power is cut, the luminaire automatically switches into emergency mode. The green LED indicator will turn OFF. The luminaire will immediately turn ON, running at 50% output using the internal battery (for 3 hours when fully charged). The microwave sensor will cease to function during this period of time.
- Once power is restored, the luminaire will once again go through its 'warm up' period. The green LED indicator will turn ON when mains power is present.
- The battery will begin to re-charge, and the luminaire will be running at full output each time the microwave sensor is activated.

3 Year Guarantee

In the unlikely event of this product becoming faulty due to defective material or manufacture within 3 years of the date of purchase, please return it to your supplier in the first year with proof of purchase and it will be replaced free of charge.

For years 2 and 3 or any difficulty in the first year, telephone the helpline on 020 8450 0515.

Note: A proof of purchase is required in all cases. For all eligible replacements (where agreed by Timeguard) the customer is responsible for all shipping/postage charges outside of the UK. All shipping costs are to be paid in advance before a replacement is sent.



If you experience problems, do not immediately return the unit to the store. Telephone the Timeguard Customer Helpline;

HELPLINE

020 8450 0515

or email helpline@timeguard.com

Qualified Customer Support Co-ordinators will be on-line to assist in resolving your query.



A **theben** Group Company

For a product brochure please contact:

Timeguard Limited.

Victory Park, 400 Edgware Road,

London NW2 6ND

Sales Office: 020 8452 1112

or email csc@timeguard.com

www.timeguard.com