

A

SIDE VIEW



2.5M

3M

SIDE VIEW



2.5M

12M

TOP VIEW

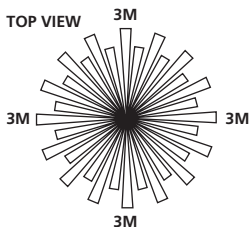

3M

3M

3M

3M

TOP VIEW

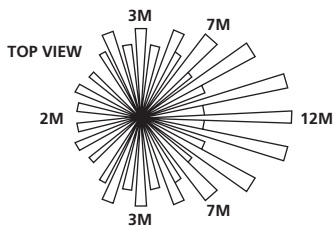

3M

7M

2M

12M

3M

7M

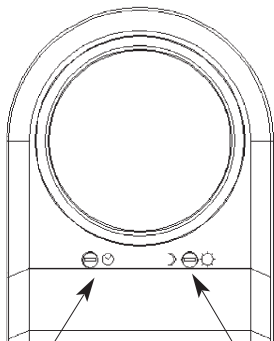
BLess
sensitiveMore
sensitive**C**

Time

Dusk

SECTION ONE

GENERAL INFORMATION

The unit utilises passive infrared technology to detect heat radiation from moving human bodies. Upon detection, the lamp will illuminate for a user-determined time period. An integral daylight sensor ensures night-only operation.

PARTS INCLUDED

- PIR Sensor Unit.
- Instruction manual. Please keep safe for future reference.
- Accessory Pack.
- Corner mount bracket

TOOLS & PARTS NEEDED

- 3 core cable
- Electric/hand-held drill & bits.
- Terminal or Electricians screwdriver
- Large slotted/philips screwdriver
- Wire cutters

Lighting loads connected must not exceed maximum 2000W filament or 500W fluorescent/low energy lighting. It is not recommended to use this product with discharge lighting. Do not attempt to install during wet weather, if you are suffering from nausea or dizzy spells or on medication with similar side effects. If in any doubt, consult a qualified tradesperson or electrician.

SECTION TWO

SELECTING THE LOCATION

Please note:- PIR sensors are not suitable for installation in glass enclosures such as porches or conservatories. PIR sensors do not detect through glass and need a clear unobstructed view of intended detection area.

The motion detector has a number of detection zones, at various vertical and horizontal angles as shown (see diagram A). A moving human body needs to cross/enter one of these zones to activate the sensor. The best all-round coverage is achieved with the unit mounted at the optimum height of 1.8m.

Careful positioning of the sensor will be required to ensure optimum performance. See diagram A detailing detection range and direction. The sensor is more sensitive to movement ACROSS its field of vision than to movement directly TOWARDS (see diagram B). Therefore position the unit so that the sensor looks ACROSS the likely approach path. Avoid positioning the sensor where there are any sources of heat in the detection area (extractor fans, tumble dryer exhausts etc). Reflective surfaces (ie pools of water, conservatories or white-painted walls) and overhanging branches may cause false activation under extreme conditions. During extreme weather conditions the motion sensor may exhibit unusual behaviour. This does not indicate a fault with the sensor. Once normal weather conditions return, the sensor will resume normal operation

LIGHT POLLUTION

To reduce the risk of light pollution, consider the following when installing the unit. Position the unit to ensure that the light emitted does not encroach onto neighbouring properties. Angle the floodlight downward to focus the illumination onto the ground, not into the sky. Consider using a lower wattage bulb to save energy and reduce high light output if not required.

SECTION THREE

INSTALLATION

After choosing a suitable location (see previous section) install the unit as follows:

The unit is suitable for connection to a 230 V ac 50Hz electricity supply. It is suggested that 3-core round flexible cable of 1sq mm is used. An internal switch should be installed to switch the power to the unit ON & OFF. This allows the sensor to be easily switched off when not required or for maintenance purposes.

Slide the mounting plate in a downward direction to release.

Mark the position of the fitting holes.

Drill the holes. Insert the rawl plugs into the holes.

PIERCE & PASS THE CABLE THROUGH THE GROMMET BEFORE PROCEEDING.

It is recommended that the grommet is pierced with a screwdriver to ensure a better seal.

Attach the mounting plate to the wall using suitable screws. Do not overtighten the mounting screws as this could damage the mounting plate.

*** IMPORTANT ***

Switch off the electricity at the fuse box by removing the relevant fuse or switching off the circuit breaker before proceeding with the installation.

CONNECTION

Connect the mains supply cable to the terminal block on the unit as follows (see connection diagram):

NEUTRAL (Blue)	N
EARTH (Green/Yellow)	
LIVE (Brown)	L

Connect the cable from the lighting load to the terminal block on the unit as follows (see connection diagram):

NEUTRAL (Blue)	N
EARTH (Green/Yellow)	
LIVE (Brown)	L'

Ensure that all connections are secure.

For details of override connections, please see connection diagram.

Re-affix the terminal block back onto the wall mounting plate (diagram D).

Slide the main body back onto the mounting plate then pull in a downwards direction so that it is fully engaged with the mounting plate (diagram E).

Secure the unit by replacing the screw on the underside.

CONNECTION DIAGRAM

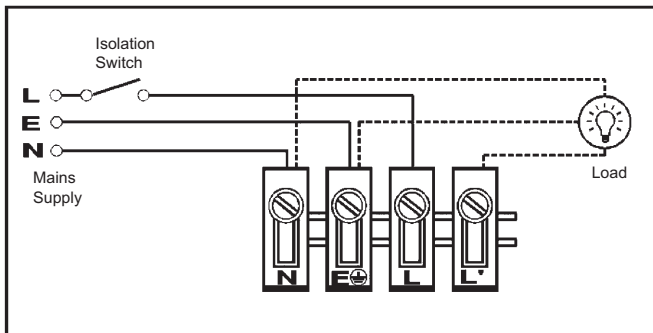

INSTALLING WITH AN OVERRIDE CONNECTION

If a manual override connection is required, follow the connection diagram below. Note that in this case it is best to use 4-core supply cable.

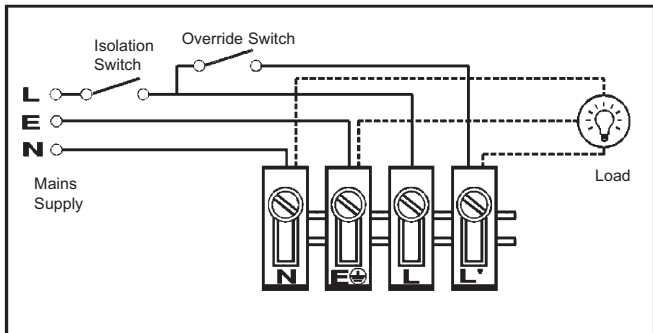

SECTION FOUR

OPERATION AND TESTING

WALK TESTING PROCEDURE

The sensor will rotate from left to right, and tilt forward or backward.

The small arrow on the underside of the sensor indicates the direction of the main detection area.

Adjust the sensor to point in the desired direction.

Set the two adjustment controls on the underside of the unit (diagram C) to the following positions:

TIME - Fully anti-clockwise

DUSK - Fully clockwise

The unit will now operate during daytime as well as at night, illuminating the lamp for approx. 5 seconds each time. This allows testing to be carried out to establish the best position for the sensor.

The lamp will immediately illuminate as the unit goes through its "warm-up" period. After approximately 1 - 2 minutes the lamp will extinguish. Try to remain outside the detection area during the warm-up period.

Walk across the detection area approx 2.5 metres from the unit. As you cross a detection "zone" the lamp will illuminate. Now stand still until the lamp extinguishes (this should take approx. 5 seconds).

Start moving again. As you cross each "zone" the lamp will illuminate.

Repeat the above, walking at various distances and angles to the unit. This will help you to establish the detection pattern.

If the detection area is too small for your requirements, try angling the sensor head up. This will increase the coverage distance. Angling the head downwards will reduce the range should a smaller coverage area be required.

SETTING UP FOR AUTOMATIC OPERATION.

When walk tests are complete, the unit can be switched to automatic operation :

The TIME setting controls how long the unit remains illuminated following activation & after all motion ceases. The minimum time (fully anti-clockwise) is approx. 5 seconds, whilst the maximum time (fully clockwise) is approx. 18 minutes. Set the control to the desired setting between these limits.

The DUSK control determines the level of darkness required for the unit to start operating. The setting is best achieved by the procedure below:

Set the DUSK control knob fully anti-clockwise. Wait until darkness falls.

When the ambient light level reaches the level of darkness at which you wish the lamp to become operative (ie. At dusk), SLOWLY rotate the control in a clockwise direction until a point is reached where the lamp illuminates. Leave the control set at this point.

At this position, the unit should become operative at approximately the same level of darkness each evening. Observe the operation of the unit. If the unit is starting to operate too early (ie. when it is quite light), adjust the control slightly anti-clockwise. If the unit starts to operate too late (ie. only when it is very dark), adjust the control slightly clockwise. Continue to adjust until the unit operates as desired.

SECTION FIVE**TECHNICAL SPECIFICATIONS**

Detection Range	Up to 12 metres
Detection Angle	360°
Power Supply	230 V AC ~ 50Hz
Maximum Switchable Load (including fitted lamp)	2000W Filament lighting, 500W Fluorescent/low energy lighting (not suitable for discharge lighting)
Time On Adjustment	5 seconds - 18 minutes
Dusk Level Adjustment	Day & night or night only operation
Environmental Protection	IP44 (suitable for outdoor use)
EC Directives	Conforms to 73/23/EEC, 89/336/EEC

**If you experience problems refer to Troubleshooting Guide.
If problems still exist, do not immediately return the unit to store.**

Telephone the Timeguard Customer Helpline

020 8450 0515

Qualified Customer Support Co-ordinators will be on-line to assist in resolving your query.

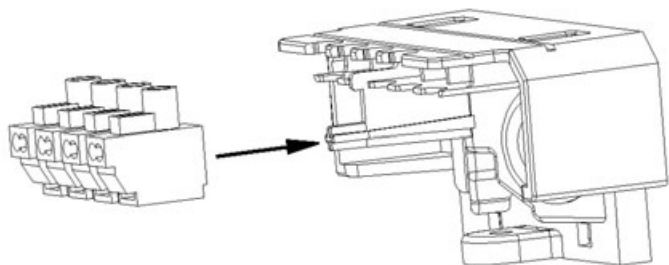
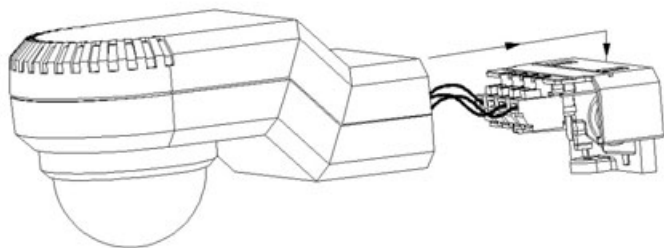
D**E**

SECTION SIX

TROUBLESHOOTING GUIDE

PROBLEM

SOLUTION

❑ Lamp stays ON all the time at night.

The unit may be suffering from false activation. Cover the sensor lens completely with a thick cloth. This will prevent the sensor from "seeing" anything. If the unit now switches off after the set time duration and does not re-activate, this indicates that the problem was caused by false activation. The problem may be solved by slightly adjusting the direction/angle of the sensor head (see section 4).

❑PIR keeps activating for no reason / at random.

You may not be allowing the unit time to complete its warm-up period. Stand well out of the detection range and wait (the warm-up period should never exceed 18 minutes). Occasionally, winds may activate the sensor. Sometimes passages between buildings etc. can cause a "wind tunnel" effect. Ensure the unit is not positioned so as to allow detection of cars/people using public thoroughfares adjacent to your property.

❑PIR sensor will not operate at all.

Check that the power is switched ON at the circuit breaker/internal wall switch.

Turn OFF the power to the unit and check the wiring connections as per the diagram (see previous section 3). Ensure no connections are loose.

Check the lamp. If the lamp has failed, replace. Ensure that the lamp is seated correctly in the lampholder.

❑The PIR sensor will not operate at night.

The level of ambient light in the area may be too bright to allow operation at the current DUSK setting. During the hours of darkness, adjust the DUSK control slowly clockwise until the lamp illuminates. Refer to section 4 for more details.

❑ Unit activates during the daytime

The level of ambient light in the area may be too dark for the current DUSK setting. During daylight, adjust the DUSK control slightly anti-clockwise. When the lamp load extinguishes, enter the detection area. If the PIR still activates, the setting is still too high. Repeat the above procedure until the PIR does not activate when you enter the detection area. Refer to section 4 for more details.

❑PIR coverage is poor/sporadic

Unit may be poorly located. See section 2 - 'Selecting The Location' and re-locate the unit.

❑Detection range varies from day to day

PIR sensors are influenced by climatic conditions. The colder the ambient temperature, the more effective the sensor will be. You may need to make seasonal adjustments to the sensor head position to ensure trouble-free operation all year round.

GUARANTEE

5 YEAR

In the unlikely event of this product becoming faulty due to defective material or manufacture, within 5 years of the date of purchase, please return it to your supplier in the first year with proof of purchase and it will be replaced free of charge. For years 2 to 5 or any difficulty in the first year telephone the helpline on 020 8450 0515.

Should you encounter any difficulty please contact our helpline on 020 8450 0515.

FIVE YEAR



GUARANTEE

Helpline
020-8450-0515



For a product brochure please contact:

Timeguard Ltd.
Victory Park, 400 Edgware Road,
London NW2 6ND
or email csc@timeguard.com