

SYN 168 g
Nr. 168 0 033

SUL 188 g
Nr. 188 0 033

SYN 168 hw
Nr. 168 0 108

SUL 188 hw
Nr. 188 0 108

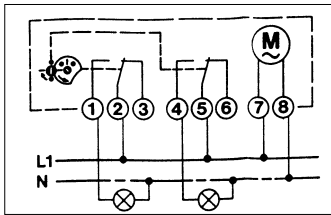
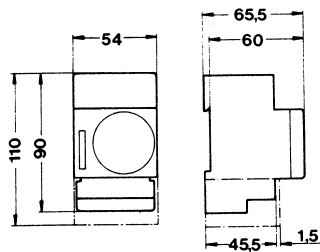
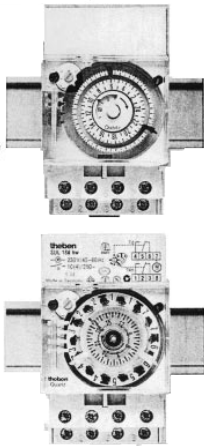

Connection to supply:

The time switches are in accordance with the European directives 73/23/EEC. (Low-Voltage Directive) and 89/336/EEC (EMC-Directive). If the time switches are used together with other devices in an installation, take care that the complete installation does not cause a radio interference.

a)

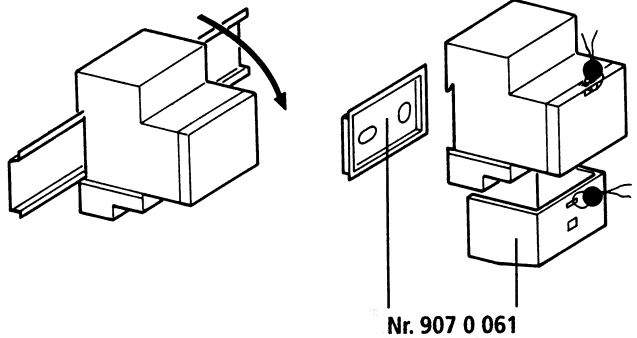

Nr. 907 0 061

MOUNTING INSTRUCTIONS

Safety information: Electrical devices should only be connected and mounted by an electrical specialist. Manipulations and modifications on the switch will result in loss of warranty. The national specifications and applicable safety regulations must be observed.

Assembly: a) Assembly on the distributing rod (mounting rail)
b) structural assembly with clamp cover indent. code 907 0 061

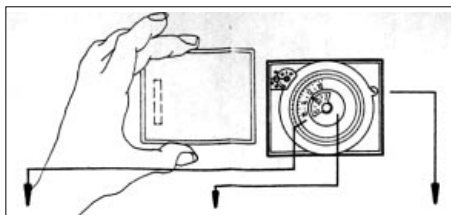

Setting the time

Set approximately by turning programme dial

Set exactly using knob

Going Indicator. The quartz movement starts automatically after a few minutes, by an applied voltage. The full power reserve is built up after about 3 days. Synchronous drive: starts immediately after c.t.p.s.

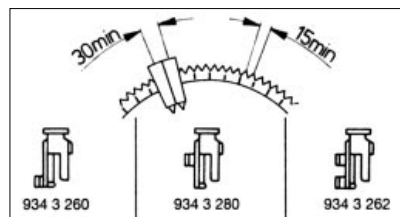

24 Hour Dial Programming

red: ④ ⑤ and ⑤ ⑥ alternatively on-off

blue: ① ② and ② ③ alternatively on-off

white: ① ② - ② ③ and ④ ⑤ - ⑤ ⑥ together or alternatively on-off. Switching tolerances between the contacts up to 5 mins (24 hrs).

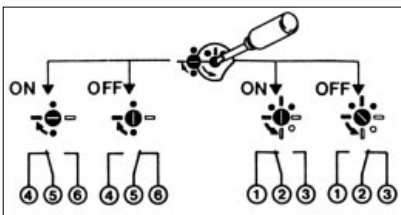

Hand switch for setting the correct programming sequence (on / off)

The hand switch must be turned only in the direction of the arrow indicator and no tappets should be engaged.

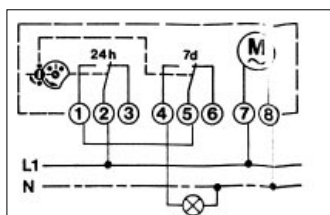

Connexion to supply

Example of connection (blue) for identical daily. Programming with a facility of interrupting the programme at the weekend or particular weekdays.

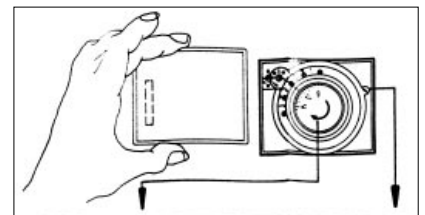

Setting the time

time of day and switch point markings (e.g. Tuesday = 2 / 12.30) turn the 24 hour switch disc (dial) until the correct day of the week and time of day shows at the indicator mark

Going Indicator. The quartz movement starts automatically after a few minutes, by an applied voltage. Synchronous drive: starts immediately after c.t.p.s.

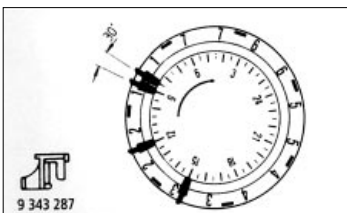

24 Hour Dial Programming

Yellow tappets switch alternatively ① ② and ② ③ on-off. For switch programme 2 tappets are required.

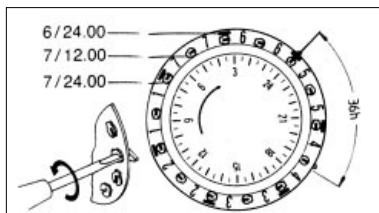

7 Day Dial Programming

Switch segments switch alternatively ④ ⑤ and ⑤ ⑥ on-off. Switch segments will fault in function if turned through 90° to the left. Each of the 14 switch segments can be applied to ON and OFF switching. Red = Sunday = 7 Blue = weekdays = 1 - 6.

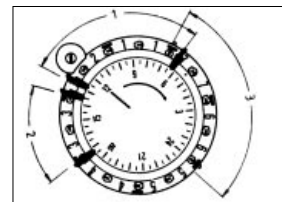

Example of how to make use of it: (Say) Office lighting.

Control by means of 24 hr and 7 day switch dial. Workdays: 6.15 - 12.45 ① and 13.30 - 17.15 ② lighting switched on. Weekends: Interruption of the daily programmes through the week switching dial from Friday 24.00 hrs until Sunday at 24.00 ③.