

RAMSES 850 OT

📄 Operating instructions

OPENTHERM

Clock thermostat

310 ###

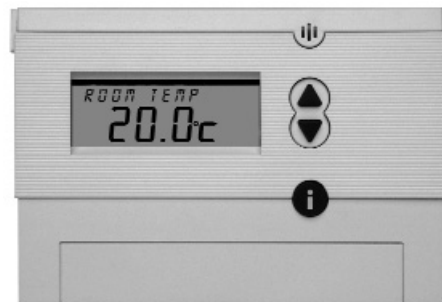

What is a programmable room thermostat?

... an explanation for householders

A programmable room thermostat is both a programmer and a room thermostat. A programmer allows you to set 'On' and 'Off' time periods to suit your own lifestyle.

A room thermostat works by sensing the air temperature, switching on the heating when the air temperature falls below the thermostat setting, and switching it off once this set temperature has been reached.

So, a programmable room thermostat lets you choose what times you want the heating to be on, and what temperature it should reach while it is on. It will allow you to select different temperatures in your home at different times of the day (and days of the week) to meet your particular needs.

Turning a programmable room thermostat to a higher setting will not make the room heat up any faster. How quickly the room heats up depends on the design of the heating system, for example, the size of boiler and radiators.

Neither does the setting affect how quickly the room cools down. Turning a programmable room thermostat to a lower setting will result in the room being controlled at a lower temperature, and saves energy.

The way to set and use your programmable room thermostat is to find the lowest temperature settings that you are comfortable with at the different times you have chosen, and then leave it alone to do its job. The best way to do this is to set low temperatures first, say 18 °C, and then turn them up by one degree each day until you are comfortable with the temperatures.

You won't have to adjust the thermostat further. Any adjustments above these settings will waste energy and cost you more money. If your heating system is a boiler with radiators, there will usually be only one programmable room thermostat to control the whole house. But you can have different temperatures in individual rooms by installing thermostatic radiator valves (TRVs) on individual radiators. If you don't have TRVs, you should choose a temperature that is reasonable for the whole house. If you do have TRVs, you can choose a slightly higher setting to make sure that even the coldest room is comfortable, then prevent any overheating in other rooms by adjusting the TRVs.

The time on the programmer must be correct. Some types have to be adjusted in spring and autumn at the changes between Greenwich Mean Time and British Summer Time. You may be able to temporarily adjust the heating programme, for example, 'Override', 'Advance' or 'Boost'. These are explained in the manufacturer's instructions.

Programmable room thermostats need a free flow of air to sense the temperature, so they must not be covered by curtains or blocked by furniture. Nearby electric fires, televisions, wall or table lamps may prevent the thermostat from working properly.

Table of Contents

1.	Designated Use	18
2.	Safety Instructions	18
3.	Description and Mounting of the Device	18
3.1.	Device Overview	19
3.2.	Mounting and Electrical Connection	20
	Mounting	20
	Electrical Connection	20
	Connection of External Temperature Sensors	20
4.	Installation and Operation	21
4.1.	Carrying out a Reset	21
4.2.	Selecting the Language	21
4.3.	Setting the Time / Date	21
4.4.	Selecting the Temperature Profile	22
4.5.	Party / Eco Program	23
4.6.	Info Button – Checking Current Room Temperature and Settings	23
5.	Control Systems / Types	24
5.1.	Settings for Room-Temperature-Compensated Control	24
5.1.1.	Setting Target Temperature	24
5.1.2.	Temporarily Changing the Target Temperature	25
5.2.	Setting for Weather-Compensated Control	25
5.2.1.	Setting the Heating Curve	25
5.2.2.	Temporarily Changing the Temperature Curve	26
5.2.3.	Disconnecting the Heating	26
6.	Programming	27
6.1.	Setting the Target Temperature	27
6.2.	Setting the Time / Date	27
6.3.	Program P3 (Heating and hot water)	28
6.4.	Setting the Holiday Program	31
6.5.	Service Settings	31
6.5.1.	Overview	31
6.5.2.	Selecting the Display Type	31
6.5.3.	Selecting Hot Water	32
6.5.4.	Setting the Wall Compensation	32

6.5.5.	Selecting the Language	32
6.5.6.	Enabling Household Water by Selecting "hot water immediately"	32
6.5.7.	Heating Switch-Off Depending on Outdoor Temperature (only Weather-Compensated Control)	33
7.	Delivery / Software Reset	33
8.	Maintenance and Repair	33
9.	Disposal	33
10.	Technical Data	34

1. Designated Use

The **RAMSES 850 OT** regulates the room and household water temperature depending on room or weather compensation and time. The room thermostat must only be operated with boilers having the symbol OpenTherm  or in connection with an OT-box 815/ 816/ 817 or 855. The system consists of **RAMSES 850 OT** and a OT-Box. It switches an electrical load with a maximal current consumption of 8 (1)A (e. g. a circulation pump, a burner or a motor mixing valve) on and off depending on time and temperature. This product must be installed in a clean, dry rooms using the manufacturers instructions.

Designated use also includes adherence to the operating and mounting instructions. Any other use is considered contrary to the designated use. The manufacturer cannot be held liable for damages resulting from such use.

2. Safety Instructions



The connection and installation of electrical devices must only be carried out by a qualified technician.

The national regulations and respective safety instructions are to be observed. Interferences and changes to the device will lead to cancellation of the warranty.

3. Description and Mounting of the Device

3.1. Device Overview

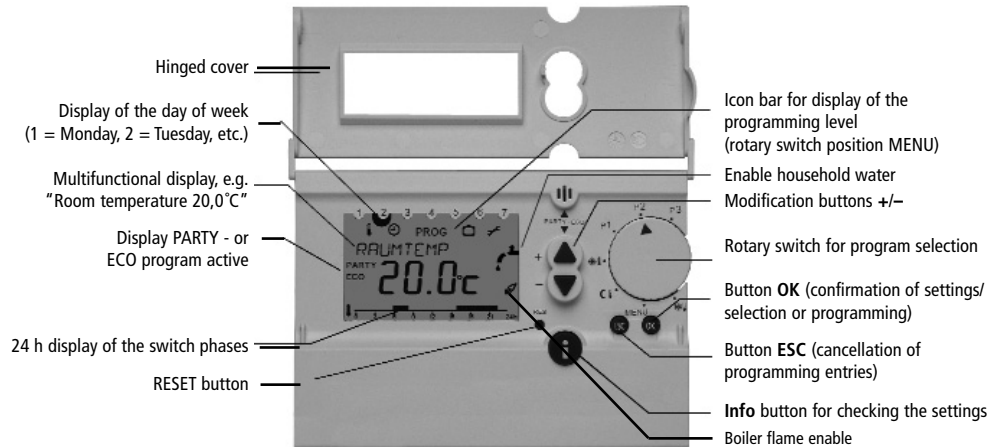

3.2. Mounting and Electrical Connection



Mounting

- First, fix the back plate of the **RAMSES 850** top using the enclosed fixings. Use the back plate as drilling pattern.
- Avoid fixing the room thermostat to an exterior wall, see note 6.5.4.

The ideal place is an interior wall at about 1.5 m height.

- Do not install near radiators, windows, televisions or heat dissipating devices.

The room thermostat measures the temperature of the room in which it is placed and regulates it according to the programmed specifications. Therefore, avoid an unintentional interference with the measurement of temperature; errors could occur in the temperature control.

Electrical Connection



The heating boiler with OpenTherm connection provides the thermostat with power. For that purpose the boiler is equipped with a safety transformer.

The two-wire low voltage connection (OpenTherm) is not polarized, i.e. the wires can be connected as desired to the terminals of the heating boiler.

Do not lay the thermostat cable in the same cable channel as the 230 V mains cable.

Do not lay it parallel to a power cable.

Before connecting the thermostat, disconnect the heating boiler from mains by unplugging the mains cable.

Attention



The thermostat must not be connected directly to a 24 V connection or to the terminal for an ON/OFF-thermostat.

This could cause irreparable damage to the thermostat.

Make sure that the thermostat is connected to the right terminals before you connect the heating boiler again to the power supply. Interferences and changes to the thermostat will lead to the loss of warranty claims.

Note

Only connect this thermostat to a boiler with the OpenTherm Logo .

Weather Compensation Control

You can connect an external temperature sensor to the terminal with the designation "DIGI". The room thermostat automatically recognizes the sensor and regulates the temperature measured by the remote sensor.

4. Installation and Operation

4.1. Carrying out a Reset

After first applying power by means of the OpenTherm connection, you must carry out a reset. Open the hinged cover and press on the reset button with a pointed object.



4.2. Selecting the Language

1. After the first reset or the reset to factory setting, the display shows the language selection.

(Resetting the device to factory setting, see chap. 7)

2. Select your language with the ▲ or ▼ buttons. The available languages are displayed one after the other. Confirm with the OK button.

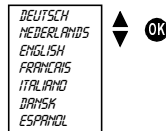

3. The display will then automatically switch to the time setting.

Note: The language can also be changed in the *SETTINGS* menu (see chap. 6.5.5.)

4.3. Setting the Time / Date

After selecting your language, the display automatically switches to the time and date setting. With the ESC button you can always return to the previous programming step and change the setting already entered.

1. The display shows the time.



2. Use the buttons ▲ and ▼ to set the current time.

Set the hour and confirm with the OK button.



Set the minutes and confirm with the OK button.

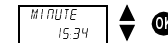

3. The display shows the date.

Set the year, month and day one after the other.

Confirm each setting with the OK button. The display changes automatically.

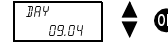
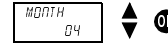

4. The display changes now automatically to the set automatic mode (e.g. display of the target temperature).

Note: Time and date as well as setting of the automatic changeover from summer to winter time can also be changed in the *CLOCK/DATE* menu (see chap. 6.2.).

4.4. Selecting the Temperature Profile

The programs P1 and P2 are fixed heating and household water programs are factory set and cannot be changed.



4.4.1. Program P1 (fixed program)

Comfort temperature Mo-Fr from 6 a.m. – 10 p.m. as well as Sa-Su from 7 a.m. – 11 p.m. Outside of these times the unit switches to a lower temperature. Household water enabled Mo-Fr from 6 a.m. – 11 p.m. as well as Sa-Su from 7 a.m. – 12 p.m. In between household hot water is not produced.

4.4.2. Program P2 (fixed program)

Comfort temperature Mo-Fr from 6 a.m. – 8 a.m. and from 4 p.m. – 10 p.m. as well as Sa-Su from 7 a.m. – 11 p.m. Outside of these times the unit switches to a lower temperature. Household water enabled Mo-Fr from 6 a.m. – 9 a.m. and from 4 p.m. – 11 p.m. right through as well as Sa-Su from 7 a.m. – 12 p.m. In between household water is not produced.

4.4.3. Program P3 (freely programmable)

The program P3 is an individually programmable temperature profile. Program P3 is not programmed when delivered (for programming see chap. 6).

If the program P3 has no setting for the programming of household water, the hot water program of P1 is used for the timer control of household water. In order to program the heating and household profile, there are 32 program locations available. The program locations are not separated into heating and household water, but used for both.

4.4.4. Permanent Comfort ☀️ ↓

The room temperature is permanently regulated to the programmed comfort temperature. There is no reduction.

4.4.5. Permanent Reduction ☾ ↓

The room temperature is permanently regulated to the programmed lower temperature.

4.4.6. Frost protection ❄️ ↓

The room thermostat only turns on when the room temperature falls below the programmed low temperature.

When the selector switch is positioned on "Permanent Comfort", "Permanent Reduction" or "Antifreezing", you have to choose for household water the times set in the program P3. If the program P3 has no setting, the fixed times of program P1 are used.

4.5. Party / ECO Program

With the "Party / ECO" function you can cancel the temperature profile of the set program for the next few hours (up to 23 hours and 50 minutes).

4.5.1. Setting the Party / ECO Program

1. Press both buttons ▲ and ▼ for about 2 seconds.
2. The display changes and shows the text *SAVE/ECO*. Press the ▲ or ▼ button within 3 minutes to switch to temperature level HEATING/PARTY.
3. After 3 seconds the display changes and shows the text *COMFORT*. Press the ▲ or ▼ button within 3 seconds and set the desired period in increments of ten minutes.
4. After 3 seconds, the display changes again and shows the desired target temperature with the addition PARTY (for comfort temperature) or ECO (for lower temperature). The Party or ECO program is active for the set period.

4.5.2. Early Cancellation of the Party / ECO Program

To cancel the "Party/ ECO" program, press both buttons ▲ and ▼ for about 2 seconds until the display changes. Wait another 3 seconds until the display changes back again. The Party/ECO program is cancelled and the addition PARTY or ECO disappears from the display.

4.6. Info Button – Checking Current Room Temperature and Settings

With the **Info** button you can display the current room temperature as well as all important settings of each program.

1. Press the Info button. The display shows the current room temperature for about 3 seconds. In order to continue, press the **Info** button again.
2. In this way you can check the following information one after the other:
 - Outside temperature (only for weather-compensated control)
 - Target room temperature (only for room-compensated control)
 - Current room temperature - max. forward flow temperature
 - Current forward flow temperature
 - Target forward flow temperature
 - Pump on / off
 - Date / time
 - Desired temperature profile (switch times of the set program can only be seen with opened hinged cover)
 - Display mode

5. Control Systems / Types

The **RAMSES 850 OT** can be used as room-temperature-compensated or weather-compensated control system. The controller type changes automatically. If an outdoor sensor is connected to the heating system, this is detected and the controller switches to weather-compensated control.

The weather-compensated control can not be carried out in connection with the OT BOX 815/816/817, but with the OT Box 855.

When using the room-temperature-compensated control type, the target room temperature can be set directly on **RAMSES 850 OT**. When using the weather-compensated control type, the temperature is determined by a predefined heating curve. In this case you can set the starting point and the end point of the curve. When using the temperature level **SAVE**, the curve is shifted by an adjustable value in parallel to the old curve. For a temporary change of temperature you can move the curve with the buttons ▲ or ▼.

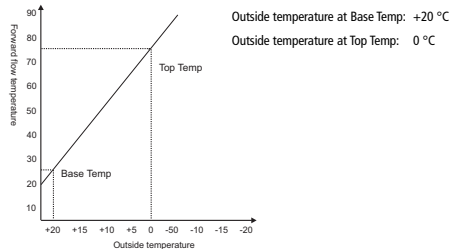

5.1. Settings for room-temperature-compensated control

5.1.1. Setting the Target Temperature

For the temperature profiles of the individual programs you can choose among three temperature values: comfort, lower and antifreeze temperature.

	Setting range	Factory setting
Comfort temperature	15 – 30 °C	21 °C
Lower temperature	10 – 29,8 °C	15 °C
Antifreeze temperature	6 – 15 °C	10 °C

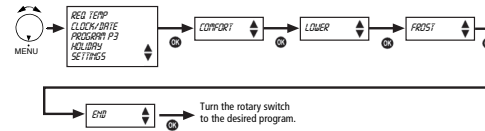

1. Open the hinged cover and turn the rotary switch to MENU.
2. Use the buttons ▲ or ▼ to select the entry **REQ TEMP**. Confirm with the **OK** button.
3. The display shows first the comfort temperature. Use the buttons ▲ or ▼ to change successively the comfort temperature, the lower temperature and the antifreeze temperature. Confirm each entry with the **OK** button. The display moves on automatically.

5.1.2. Temporarily Changing the Target Temperature

With this function you can temporarily change the target temperature given by the program. The changed target temperature is not permanently saved. It only remains set until the only until the next temperature change of the program (e.g. from comfort to lower temperature).

Note: If one of the programs "Permanent Comfort", "Permanent Reduction" or "Antifreezing" is set, the temperature change remains valid until the program changes.

1. Press the buttons ▲ or ▼. The display shows the set target temperature.
2. Change the target temperature with the buttons ▲ or ▼.
3. After approx. 3 seconds, the display automatically switches back to its original state, and the room thermostat regulates to the changed target temperature.

5.2. Setting for Weather-Compensated Control

5.2.1. Setting the Heating Curve

When using the weather-compensated control type, you have to set the starting point and the end point of the heating curve. To define the lower temperature, you can enter a parallel displacement of the heating curve.

	Setting range	Factory setting
Starting point	10 – 75 °C	25 °C
End point	25 – 85 °C	75 °C
P-movement reduction	-50 – 0 °C	-25 °C
Frost line	-5 – 10 °C	3 °C

1. Open the hinged cover and turn the rotary switch to MENU.
2. Use the buttons ▲ or ▼ to select the entry *REQ. TEMP.*
Confirm with the **OK** button.

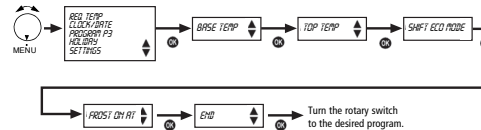

Defining the parameters for your heating system

What kind of heating system do you use?

Type of heating		Forward/backward flow temperature
Heating with radiators	High temperature	90 / 70
Heating with radiators	Middle temperature	70 / 50
Floor heating	Lowest temperature	40 / 30

Defining the parameters for your heating system

Type of heating	HC-Starting point	HC-end point End point	P-movement reduction	Frost limit
90 / 70 system	30 °C	85 °C	-15 °C	-3 °C
70 / 50 system	25 °C	75 °C	-15 °C	-3 °C
40 / 30 system	25 °C	45 °C	-15 °C	-3 °C

5.2.2. Temporarily Changing the Heating Curve

Using this function you can temporarily change the heating curve predefined by the program. You can set a parallel displacement of ± 5 . The set value causes a displacement of the heating curve of the setting *5 K. The modified heating curve is not permanently saved. It only remains set until the next temperature change.

If one of the programs "Permanent Heating", "Permanent Saving" or "Antifreezing" is set, the displaced curve remains valid until the program changes.

1. Press the buttons ▲ or ▼. The display shows the set displacement.
2. Use the buttons ▲ or ▼ to change the displacement.
3. After approx. 3 seconds, the display automatically switches back to its original state, and the room thermostat regulates to the modified target temperature.

5.2.3. Disconnecting the Heating

When using the weather-compensated control type, you can program the controller so that the heating switches off at a set outside temperature.

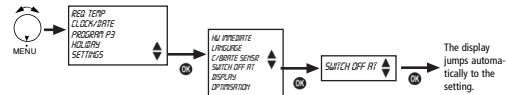

The set times of program P3 also apply to household water in case of weather-compensated control. If the program P3 has no setting, the fixed times of program P1 are used.

6. Programming

Note: The programs P1 and P2 are fixed programs ex works and cannot be changed.

6.1. Setting the Target Temperatures

See section 5.

6.2. Setting the Time / Date

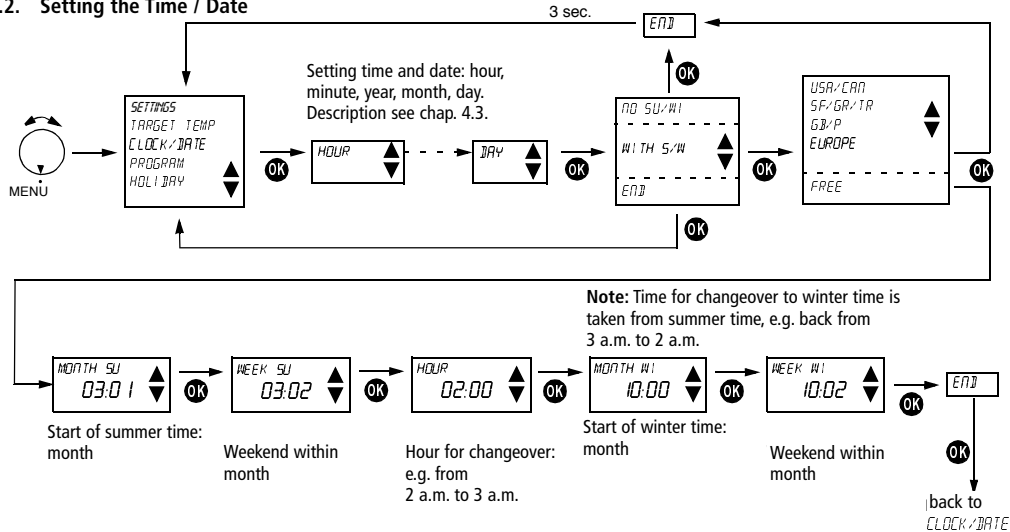

6.3. Program P3 (Heating and Hot Water)

The programming of the heating and hot water program P3 is to be set via the PROGRAM menu. The settings of the temperature profiles are to be carried out in the same way for heating and hot water.

Setting heating and hot water program

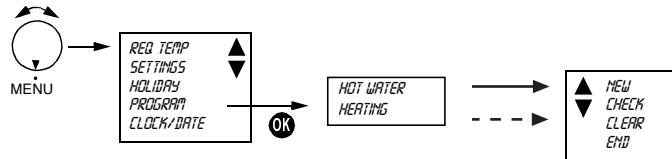

Setting new temperature profile P3

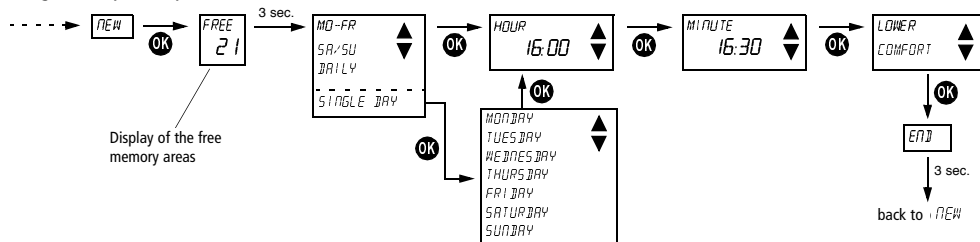

Checking temperature profile P3

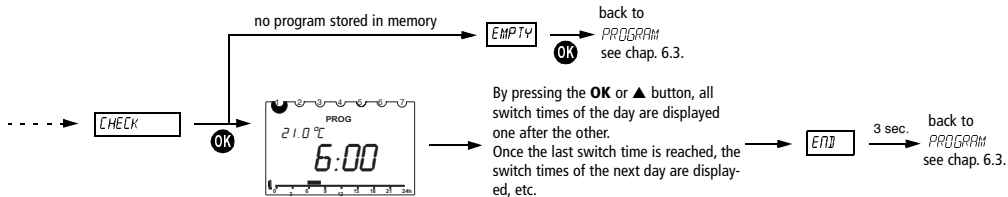

Clearing the temperature profile

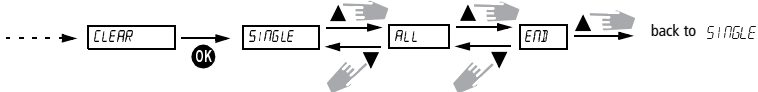

Displaying individual switch times and clearing them

1. Displaying the switch times

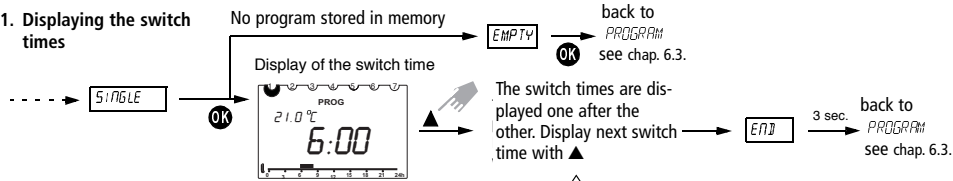

2. Clearing the desired switch times



Clearing all switch times

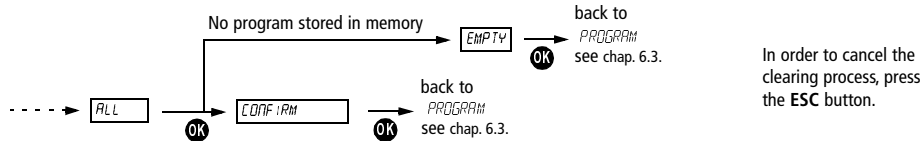

6.4. Setting the Holiday Program

By setting a holiday program, the temperature profile of the set automatic program can be cancelled for any period of time.

Note: With the ESC button, you can cancel the programming at any time.

1. Open the hinged cover and turn the rotary switch to MENU.
2. Use the buttons ▲ or ▼ to select the entry *HOLIDAY*. Confirm with the OK button.

Note: If a holiday program is already saved, you can choose if you want to check or clear it. In order to save a new holiday program, the already saved holiday program must be cleared.

3. If no holiday program has been saved yet, set the start and end date now with the buttons ▲ and ▼. Set the year, month, day and hour one after the other. Confirm each setting with the OK button. The display changes automatically.

Note: The end time must not be the same as or earlier than the start time. Otherwise an error message is displayed: *ERROR*. The holiday program must then be programmed again.

6.5. Service Settings

6.5.1. Overview

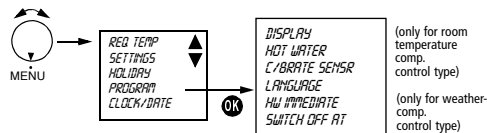

6.5.2. Selecting the Display Type

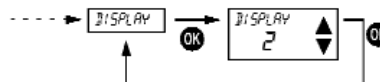

Select the display with the buttons ▲ or ▼. Confirm with the OK button. Cancel with ESC.

Note: The factory setting is highlighted grey in the table.

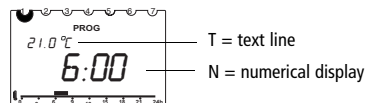

	Display type 1	Display type 2
Time	Text line	Numerical display
Actual temp.	Numerical display	Text line

On delivery, the display type 1 is set.

6.5.3. Selecting Hot Water

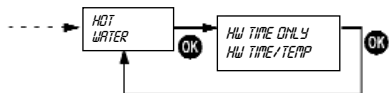

With the setting HW TIME ONLY, you can only have hot water. With TEMP, the setting of the boiler is taken over. With the setting HW TIME/TEMP, you can additionally define the HW target temperature.

6.5.4. Setting the Wall Compensation

If an unsuitable wall has to be used to mount the thermostat (installation at the exterior wall, chimney, etc.), there may be deviations in temperature between the temperature measured by the thermostat and the actual room temperature. This difference in temperature can be compensated with the wall compensation by setting an offset value (the wall compensation can be set within a range of ± 6 °C).

Example: The difference between the measured and the controlled temperature is 2 °C, i.e. the room temperature is regulated 2 °C too high: Offset value -2 °C.

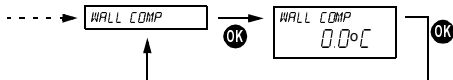

Offset value adjustable from -3 °C ... $+3$ °C. Setting with the buttons \blacktriangle or \blacktriangledown . Confirm the value with OK (cancel with ESC).

6.5.5. Selecting the Language

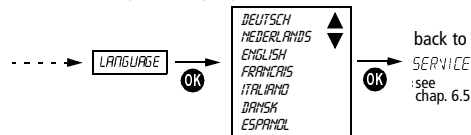

Select the language with the buttons \blacktriangle or \blacktriangledown . Confirm with the OK button. Cancel with ESC.

6.5.6. Enable Household Water by Selecting "hot water immediately"

With this function, household water can be heated and enabled once, regardless of the times set in the program.



Setting with the buttons \blacktriangle or \blacktriangledown . Confirm the value with OK (cancel with ESC).

6.5.7. Heating Switch Off Depending on Outdoor Temperature (only Weather-Compensated Control)

In the menu *SETTINGS* the display shows the text *HEATING OFF AT*. Now, you can enter the temperature for the heating switch off depending on outdoor temperature.

You can set values between 10 °C and 25 °C. This function can be deactivated by setting the value 99 °C.

6.5.8. Optimum Start

6.5.8.1 Room Temperature Control Mode

1. Turn the rotary switch to position MENU.
2. With button ▲ go to *SETTINGS*. Confirm with the **OK** button.
3. With button ▲ go to *OPTIMISATION*. Confirm with the **OK** button.
4. Select with button ▲ minutes (min: 0, max: 60 minutes; default value is 0, that means optimisation is switched off). Confirm with the **OK** button.

If value 15 is adjusted it means 15 minutes/°C.

Example

- Actual temperature is 18 °C
 - Comfort temperature is 21 °C
 - Difference between Lower and Comfort temperature is 3 °C
- ⇒ Value for optimisation 15 minutes/°C

It is wished to have at 7:00 Comfort, the heating starts at 6:15 hours. It starts 3 °C x 15 minutes = 45 minutes earlier than 7:00 o'clock. If program switches from Comfort to Lower temperature optimisation is not used. That means there is comfort temperature until programmed time. Lower temperature does not start earlier.

6.5.8.2 Weather Compensation Mode

1. Turn the rotary switch to position MENU.

2. With button ▲ go to *SETTINGS*. Confirm with the **OK** button.
3. With button ▲ go to *OPTIMISATION*. Confirm with the **OK** button.
4. Select with button ▲ minutes (min: 0, max: 60 minutes; default value is 0, that means optimisation is switched off). Confirm with the **OK** button.

If value 15 is adjusted it means 15 minutes/°C flow temperature.

Example

- Control temperature is according to calculated curve: at 10 °C
- Outside temperature 45 °C flow temperature
- Lower temperature is flow temperature –30 °C

⇒ Value for optimisation 15 minutes/°C

It is wished to have at 7:00 Comfort, the heating starts at 6:15 hours. It starts 3 °C x 15 minutes = 45 minutes earlier than 7:00 o'clock.

If program switches from Comfort to Lower temperature optimisation is not used. That means there is Comfort temperature until programmed time. Lower temperature does not start earlier.

Switch from weather compensation control to room temperature control and versus

If customer press for more than 5 seconds **OK** button it changes from weather compensation control to room temperature control or versus. Weather compensation can only be activated if outside temperature sensor is connected to the boiler.
We show weather compensation mode with a small symbol in the display ##.

7. Delivery / Software Reset

With the buttons **ESC** and **OK**, you can reset the factory delivery settings of **RAMSES 850 OT**. By pressing the buttons **ESC** and **OK** simultaneously for a longer time (about 2 sec.), a selection menu appears. Two types of software reset are available.

Following values are reset:

Software reset step 1:

Target temperature (comfort):	21 °C
Target temperature (reduction):	15 °C
Target temperature (antifreezing):	10 °C
Heating curve starting point:	25 °C
Heating curve end point:	75 °C
Reduction saving mode:	-25 K
Holiday program:	deleted
Heating program P3:	deleted
Household water program P3:	deleted
Hot water immediately:	reset
Display:	1

In step 1, time and language settings are not affected.

Software reset step 2 (additional to step 1):

Time:	12:00
Language:	German
Date:	reset

8. Maintenance and Repair

RAMSES 850 OT is maintenance-free. Only clean the device with a dry or slightly damp, soft and lint-free cloth. The interior of the device must remain free from water.

9. Disposal

At the end of its life, the room thermostat must be dismantled professionally and disposed of according to the national regulations with regard to the environment. In case of doubts, please contact the manufacturer's representative in your country. Contact details can be found at the back of this manual.

10. Technical data

Control type:	Modulating controller, operates with the OpenTherm protocol
Accuracy:	±1 sec. per day by 20 °C
Control accuracy:	±0,2 K
Temperature meas. range:	0 °C to 50 °C, resolution 0.1 °C
Temperature setting range:	6 °C to 30 °C in increments of 0.2 °C
Memory spaces:	32 temperature changes, programmable for Mo-Fr, Sa-Su, each day or for individual days
Class of protection:	II according to EN 60730-1
Type of enclosure:	IP 20 according to EN 60529-1
Power reserve:	4 hours