

theben

RAMSES 818 top

Ref. Nr. 818 0 032

- ④ **Bedienungsanleitung** 1
Uhrenthermostat
- Ⓞ **Operating instructions** 17
Clock thermostat
- Ⓔ **Notice d'utilisation** 31
Thermostat à horloge
- Ⓜ **Gebruiksaanwijzing** 45
Klokthermostaat
- ① **Istruzioni per l'uso** 59
Cronotermostato
- Ⓔ **Instrucciones de uso** 73
Termostato con reloj

310 103 01



RAM 811 top



TR 610 top



RAM 797 HF



RAM 622 top



RAM 382 A

Table of Contents

1	Designated Use	17
2	Safety Instructions	17
3	Description and Mounting	18
3.1	Device Overview	18
3.2	Mounting and Electrical Connection	19
4	Installation and Operation	20
4.1	Carrying out a Reset	20
4.2	Selecting the Language	20
4.3	Setting the Time / Date	20
4.4	Selecting the Temperature Profile	21
4.5	Checking Current Temperature and Settings - Info Button	21
4.6	Temporarily Changing the Target Temperature	22
4.7	Early Cancellation, Check or Clearance of the Holiday Program	22
4.8	Party / Eco Program	2
5	Programming	23
5.1	Setting the Holiday Program	23
5.2	Changing the Settings for Target Temperatures	24
5.3	Program P3	24
5.4	Service Settings	27
5.5	Time / Date and Summer / Winter Time	29
6	Maintenance and Repair	30
7	Disposal	30
7.1	Disposal of the Device	30
8	Technical Data	30

1 Designated Use

The **RAMSES® 818 top** is a digital clock thermostat for controlling the electric underfloor heating temperature.

The designated purpose of a **RAMSES® 818 top** is to switch on and off by time and with a maximum current draw of 16 A, e.g. electrical underfloor. It may only be used in dry, domestic environments.

Designated use also includes adherence to the operating and mounting instructions. Any other usage is not allowed. The manufacturer cannot be held liable for damages resulting from this.

2 Safety Instructions



The connection and installation of electrical devices must only be carried out by a qualified technician.

The national regulations and respective safety instructions are to be observed.

Interferences and changes to the device will lead to cancellation of the warranty.

3 Description and Mounting

3.1 Device Overview

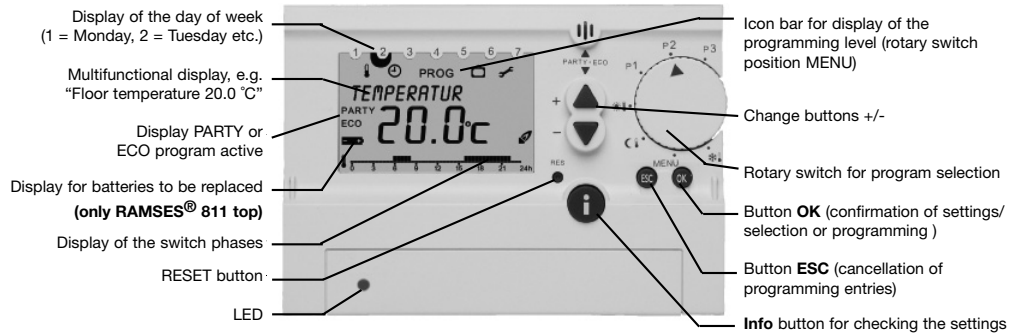

3.2 Mounting and Electrical Connection

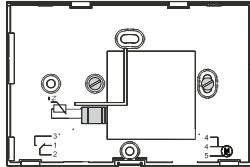

Connection terminals for temperature sensor

Connection

- Remove the connection cable from the terminal.
- Now attach the connection cable (see figure).

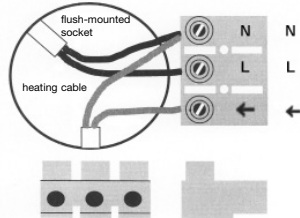

Heating cable test

Press the 'Info' key for approx. 4 secs. (with heating cable connected) until **Test Mode** appears in the display. **Test Mode** remains displayed for 8 secs. Unless the heating cable is disconnected or damaged, the green LED illuminates for the first 4 secs. in Test Mode (bottom left-hand side of the thermostat).

With the heating cable connected but not yet under the floor covering, ensure after the test that the thermostat is not set to 'Heat' (no flame shown in the display).

It is advisable to detach the thermostat and remove from the wall.

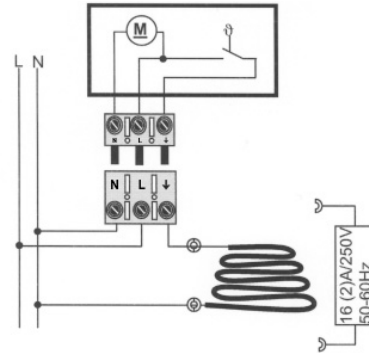

4 Installation and Operation

For installation of **RAMSES® 818 top**, follow the sections 4.1 to 4.5.

4.1 Carrying out a Reset

After having connected the power supply or having inserted the batteries (when exceeding the battery change power reserve of 10 min), you must carry out a Reset. For this purpose, open the hinged cover, and press with a pointed object on the **Reset** button which is recessed in the case (see figure below).

4.2 Selecting the Language

1. The display automatically shows the selected language after Reset.
2. Select your language with the buttons ▲ or ▼. The available languages are displayed one after the other. Confirm with the **OK** button.
3. The display automatically switches to the time setting.



Note: The language can also be changed in the "Service" menu (see page 27).

4.3 Setting the Time / Date

With the **ESC** button you can always return to the previous programming step in order to adjust a setting.

1. The display shows the time setting.
2. Set the current time with the buttons ▲ and ▼:



Set the hour and confirm with the **OK** button.



Set the minutes and confirm with the **OK** button.

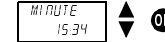

3. The display changes automatically to the date setting.
Set the year, month and date one after the other. Confirm each setting with the **OK** button. The display changes automatically.

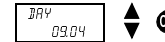
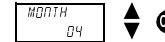

4. The display automatically changes to the set automatic mode, e.g. display of the target temperature.

Note: The time and date can also be changed in the "Service" menu (see page 27). There you can also set the changeover from winter to summer time.

4.4 Selecting the Temperature Profile

4.4.1 Program P1 (fixed program)

Comfort temperature: Mo-Fr from 5.30 a.m. - 9.00 a.m. / 21.00 p.m. - 23.00 p.m. as well as Sa-Su 7.30 a.m. - 10.30 a.m. / 21.00 p.m. - 23.00 p.m. In between lower temperature.

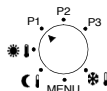

4.4.2 Program P2 (fixed program)

Comfort temperature: Mo-Fr from 6.00 a.m. - 8.00 a.m. / 20.30 p.m. - 23.00 p.m. as well as Sa-Su from 7.00 a.m. - 11.00 a.m. / 21.00 p.m. - 23.59 p.m. In between lower temperature.

4.4.3 Program P3 (freely programmable)

The program P3 is an individually programmable temperature profile. Program P3 is not programmed when delivered. For programming see page 23.

4.4.4 Permanent comfort ☀ ↓

The floor temperature is permanently regulated to the programmed comfort temperature. There is no reduction.

4.4.5 Permanent reduction ☾ ↓

The floor temperature is permanently regulated to the programmed lower temperature.

4.4.6 Antifreezing ❄ ↓

The floor temperature only comes on when the floor temperature falls below the programmed antifreeze temperature.

4.5 Checking Current Temperature and Settings - Info Button

With the **Info** button you can display the current floor temperature as well as all important settings of the program set at the rotary switch.

1. Press the **Info** button. The current floor temperature is shown in the display for approx. 3 seconds. In order to continue with the check, press the **Info** button again.
2. This way you can check the following information one after the other:
 - Floor temperature
 - Currently active target temperature
 - Date and time
 - Switch times of the set program (only visible with opened hinged cover). The fixed programmed temperature profiles and switch times are described in section 4.5.
 - Set display type, (i.e. which information is shown in the display, also see page 27).
3. The check is completed. The display automatically switches back to the original state.

4.6 Temporarily Changing the Target Temperature

With this function, you can temporarily change the target temperature given by the program. The changed target temperature is not saved long-term. It only remains set until the next temperature change of the program (e.g. from comfort to lower temperature).

Note: If one of the programs "Perm. comfort", "Perm. lower" or "Frost" is set, the temperature change remains until the program changes.

1. Press one of the buttons ▲ or ▼. The display shows the set target temperature.
2. Change the target temperature with the buttons ▲ or ▼.
3. After approx. 3 seconds, the display automatically switches back to its original state, and the floor thermostat regulates to the changed target temperature.

4.7 Early Cancellation, Check or Clearance of the Holiday Program

If you want to cancel an activated holiday program early, you must clear the holiday program.

Note: The setting of the holiday program is described in section 5.1 on page 23.

1. Open the hinged cover and turn the rotary switch to the MENU setting.
2. With the buttons ▲ or ▼, select the option *HOLIDAY*. Confirm with the **OK** button.
3. With the buttons ▲ or ▼, select the desired option and confirm with the **OK** button:
 - *CHECK:* By repeated pressing of the **OK** button, you can check all settings of the saved holiday program one after the other (start or end time, temperature).
 - *CLEAR:* By pressing the **OK** button, the saved holiday program is cleared.You can now program a new holiday program (see section 5.1 on page 21) or set the desired temperature profile (automatic program) at the rotary switch (see section 4.5 on page 21).

4.8 Party / Eco Program

With the "Party / Eco" function, you can cancel the temperature profile of the set program for the next few hours (up to 23 hours and 50 minutes).

4.8.1 Setting the Party / Eco Program

1. Press both buttons ▲ and ▼ at the same time for approx. 2 seconds.
2. The display changes and shows the text *PERIOD* and a flashing clock. Within 3 seconds, press one of the buttons ▲ or ▼, and set the desired period in increments of 10 minutes.
3. After 3 seconds, the display changes and shows the text *COMFORT* or *LOWER*. Within 3 seconds, select the comfort or lower temperature with the buttons ▲ or ▼.
4. The display changes automatically after 3 seconds. The display shows the desired target temperature with the addition "PARTY" (for comfort temperature) or "ECO" (for lower temperature). The Party or Eco program is active for the set period.

4.8.2 Early Cancellation of the Party / Eco Program

In order to cancel the "Party / Eco" program, press both buttons ▲ and ▼ for approx. 2 seconds, until the display changes. Wait another 3 seconds until the display changes back again. The Party / Eco program is cancelled, and the addition "PARTY" or "ECO" disappears from the display.

5 Programming

Note: The P1 and P2 programs are fixed programs ex works, and cannot be changed.

5.1 Setting the Holiday Program

By setting a holiday program, the temperature profile of the set automatic program can be cancelled for any period of time.

Note: With the **ESC** button, you can cancel the programming at any time.

1. Open the hinged cover and turn the rotary switch to the MENU setting.
2. With the buttons ▲ or ▼, select the entry *HOLIDAY*. Confirm with the **OK** button.

Note: If a holiday program is already saved, you can choose if you want to check or clear it. In order to save a new holiday program, the already saved holiday program must be cleared. See section 4.7 on page 22.

3. If no holiday program has been saved yet, set the start and end date now with the buttons ▲ and ▼.

Set the year, month, date and hour one after the other. Confirm each setting with the **OK** button. The display changes automatically.

Note: The end time must not be the same as or earlier than the start time. Otherwise an error message is displayed: *ERROR*. The holiday program must then be programmed again.

4. Select whether you want the comfort, the lower or the antifreeze temperature for the set period. Confirm with the **OK** button.

- The holiday program is now programmed and is activated at the set start time.
- Reset the rotary switch to the desired program and close the hinged cover.
- While the holiday program is active, the display shows the target temperature and the text line *HOLIDAY*.

Note: Checking, clearing or cancelling a holiday program is described in section 4.7 on page 22.

5.2 Changing the Settings for Target Temperatures

For the temperature profiles of the individual programs, you can choose between three temperature values: Comfort, lower and antifreeze temperature.

These temperature values are programmed ex works. You can change these according to your wishes.

- Open the hinged cover and turn the rotary switch to the MENU setting.
- With the buttons ▲ or ▼, select the entry *TARGET TEMP*. Confirm with the **OK** button.
- The display first shows the comfort temperature.
With the buttons ▲ or ▼, change the comfort, lower and antifreeze temperature one after the other. Confirm each setting with the **OK** button. The display changes automatically.

- After having set the antifreeze temperature, the setting of the target temperatures is completed. The display shows *END* and automatically changes back after 3 seconds.
- Turn the rotary switch to the desired program and close the hinged cover.

5.3 Program P3

5.3.1 Overview "Program" menu

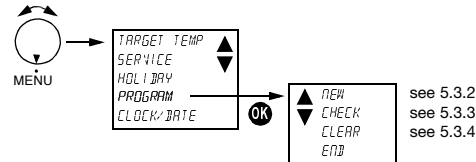

5.3.2 Creating a new temperature profile P3

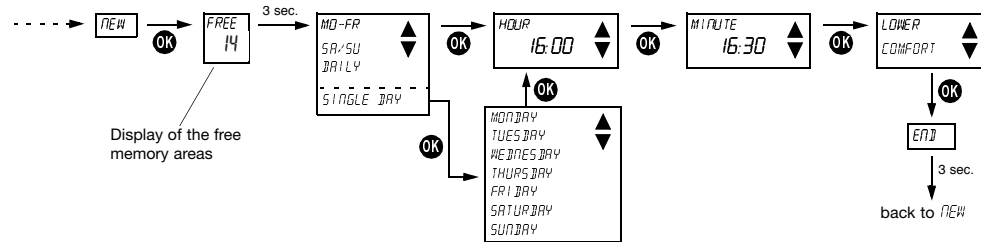

5.3.3 Checking the temperature profile P3

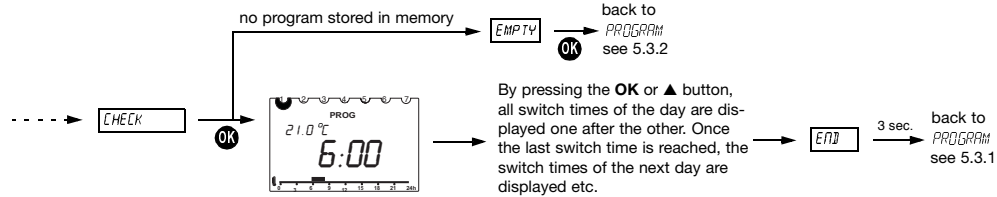

5.3.4 Clearing the temperature profile

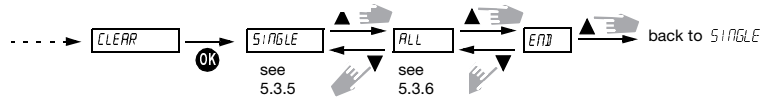

5.3.5 Displaying individual switch times and clearing them

1. Displaying the switch times

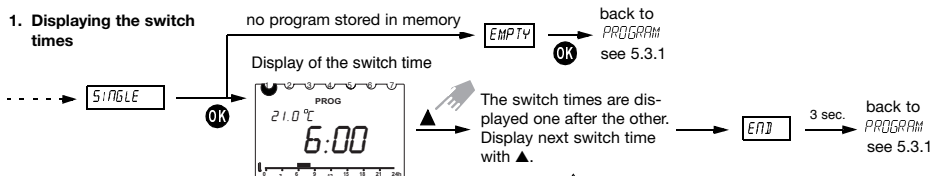

2. Clearing the desired switch times



5.3.6 Clearing all switch times

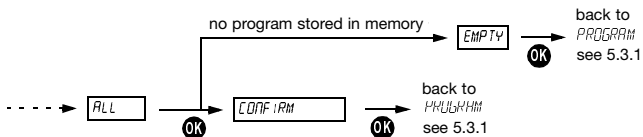

In order to cancel the clearing process, press the **ESC** button.

5.4 Service Settings

5.4.1 Overview "Service" menu

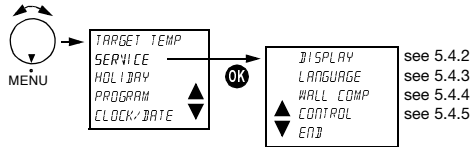

5.4.2 Selecting the display type

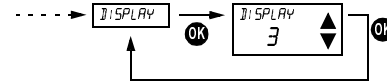

Select the display type with the button ▲ or ▼.
Confirm with the **OK** button. Cancel with **ESC**.

Note: The factory setting is highlighted grey in the table.

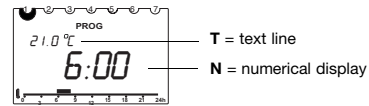

	Rotary switch position P1, P2 or P3					Rotary switch position ☀ ☾ ☁ ⚡				
	1	2	3	4	5	1	2	3	4	5
Time	T	T			N					N
Target temp.		N	N	T			N	N		
Actual temp.	N			N	T	N			N	
Program name						T	T	T	T	T

Table: Overview of the information shown in the display for different displays types.

5.4.3 Selecting the language



Select the language with the buttons ▲ or ▼.
Confirm with the **OK** button. Cancel with **ESC**.

5.4.4 Setting the sensor compensation

In case of unfavourable conditions at the installation site (installation near the cold and warm water pipes in the floor), there may be deviations in temperature between the temperature measured by the thermostat and the actual temperature. This difference in temperature can be compensated with the sensor compensation by setting an offset value.

Example: The difference between the measured and the controlled temperature is 2 °C, i.e. the temperature is regulated 2 °C too high: Offset value -2 °C.

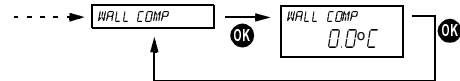

Offset value adjustable from -3 °C ... +3 °C. Setting with ▲ or ▼.
Confirm the value with **OK**. Cancel with **ESC**.

ENGLISH

5.4.5 Adjusting the controller behaviour

Characteristics of the PD controller

With suitable heating systems the PD controller is characterized by a short setting time, scarce maximum overshooting and therefore a high control accuracy.

Characteristics of a hysteresis controller

With over or under engineered heating systems a hysteresis controller is characterized by scarce shift frequency and small temperature deviations.

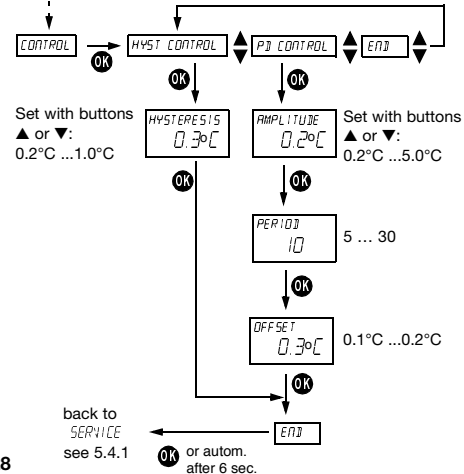

5.5 Time/Date and Summer/Winter Time

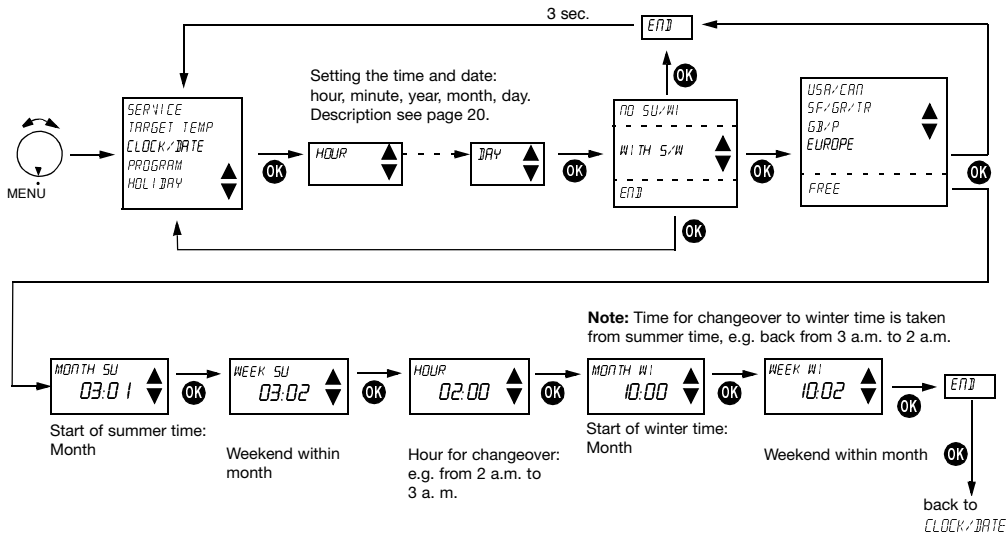

6 Maintenance and Repair

RAMSES® 818 top is maintenance-free.

Only clean the device with a dry or slightly damp, soft and lint-free cloth. The interior of the device must remain free from water.

7 Disposal

7.1 Disposal of the Device

At the end of its life, the thermostat must be dismantled professionally and disposed of according to the national regulations with regard to the environment.

In case of doubts, please contact the manufacturer's representative in your country.

Contact details can be found at the back of this manual.

8 Technical Data

Control type:	RS type 1B acc. to EN 60730-1:2001
Contact:	Change-over contact Max. 16A / 230 V~
Accuracy:	± 1 sec. per day at 20°C
Control accuracy:	± 0.2 K
Temperature meas. range:	0°C to 50°C, resolution 0.1°C
Temperature setting range:	6°C to 30°C in increments of 0.2°C
Control period:	5 to 30 min. (PD control)
Control lock-in range:	± 0.2 K to ± 5 K (PD control)
Switching hysteresis:	± 0.2 K to ± 1.0 K (hysteresis control)
Memory spaces:	14 temperature changes, programmable for Mo-Fr, Sa-Su, each day or for individual days.
Class of protection:	II according to EN 60730-1 with correct installation in a flush-mounted wall socket.
Type of enclosure:	IP 20 according to EN 60529-1
Operating voltage:	230-240 V~ / 50 to 60 Hz
Power reserve:	5 hours