

## Presence detector compact passage

Art. Nr. 201 0 090

<b>D</b>	<b>Bedienungsanleitung</b>	<b>2</b>
<b>F</b>	<b>Notice d'utilisation</b>	<b>22</b>
<b>GB</b>	<b>Installation manual</b>	<b>42</b>
<b>E</b>	<b>Manual de instrucciones</b>	<b>62</b>
<b>I</b>	<b>Istruzioni per l'uso</b>	<b>82</b>
<b>NL</b>	<b>Gebruikershandleiding</b>	<b>102</b>

**Presence detector  
compact passage****Table of contents**

1. Safety .....	39
2. Function and performance characteristics .....	40
3. Fitting and connection .....	41
4. Start-up .....	43
5. Additional wiring examples .....	47
6. Test mode .....	50
7. Technical specifications .....	51
8. Warranty declaration .....	53
9. Troubleshooting .....	54

Thank you for purchasing an Theben HTS presence detector and putting your trust in us.

## 1. Safety

### DANGER !

Any work on electrical systems must exclusively be carried out by qualified electricians or instructed persons under the direction and supervision of a qualified electrician in accordance with the relevant electrotechnical rules! Any national safety regulations regarding the manipulation of electrical systems must be observed! **The voltage supply must be disconnected prior to installation!**

### CAUTION !

The device is maintenance-free. The warranty terminates if the device is opened or entered with any kind of object.

### **Designated use**

The presence detector is solely intended for the purpose contractually specified between the manufacturer and the user. Any other or extended use has to be regarded as not complying with the designated use. The manufacturer is not liable for any resulting damage.

## 2. Function and performance characteristics

The presence detector compact passage is used for a comfortable and efficient light as well as HVAC control within a corridor.

**The switching contact A «Light»** switches on the lighting in case of presence **and** insufficient brightness, and off in case of absence **or** sufficient brightness. In addition, the lighting can be switched manually by means of push-buttons.

- Switching contact «Light»: relays 230V
- Manual control by push-button or switch
- Semi or fully automatic operation
- Push-button function: room / corridor
- Suitable for fluorescent lamps, compact energy saving lamps as well as for halogen and incandescent lamps
- Pulse function for staircase lighting timer

**The switching contact B «Presence»** controls heating, ventilation and air-conditioning systems. The contact closes in case of presence, a switch-on delay allows a delayed switching on. The contact can also be used for room surveillance purposes. Using reduced sensitivity, it only responds on very distinct movements.

- Switching contact «Presence», potential-free relay
- Adjustable switch-on delay and switch-off delay
- Surveillance function

## 3. Fitting and connection

### 3.1 Presence detection

The ideal mounting height is 2,0 - 3,5m. The sensitivity of the detector decreases with increasing mounting height. The detection ranges of multiple detectors should overlap in their fringe zone. Ensure the horizontal installation of the detector.

M'height	radial ( <b>r</b> )	tangential ( <b>t</b> )
2,0m	16,0m x 3,5m ± 1m	30,0m x 3,5m ± 1m
2,5m	18,0m x 4,0m ± 1m	30,0m x 4,0m ± 1m
3,0m	20,0m x 4,5m ± 1m	30,0m x 4,5m ± 1m
3,5m	20,0m x 5,0m ± 1m	30,0m x 5,0m ± 1m

Because of the virtually horizontal detection of compact passage to both directions, the detection range of tangential (**t**) movements of persons is different to the range of radial (**r**) movements towards the detector.

#### Detection range (mounting height 3,0m)

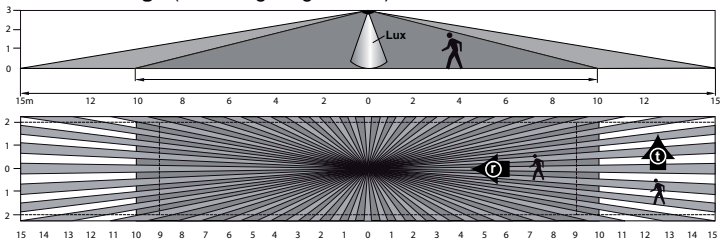

## 3.2 Light measurement

The detector measures artificial light and daylight reflected directly beneath the detector (beam width approx.  $\pm 30^\circ$ ).

The mounting location is used as the reference for the lighting levels.

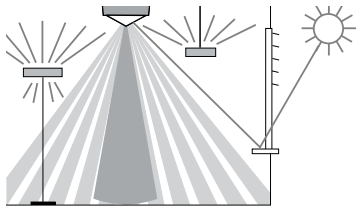

With indirect lighting, the artificial light at the detector's mounting location should not exceed 2000 Lux (Brightness value > 2000 Lux).

## 3.3 Connection

A concealed housing should be used for flush-mounted fitting of the presence detector compact passage.

A surface frame is available for surface mounting.

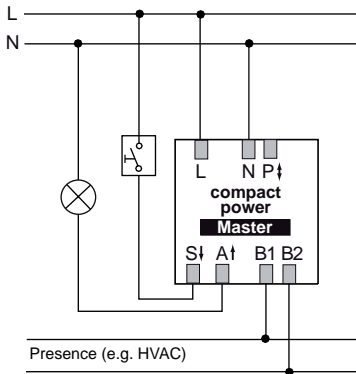

## 4. Start-up

The detectors are supplied ready for operation with a factory setting of recommended standard values.

The QuickSet plus service remote control for starting-up the system is optionally available. With the remote control all potentiometer values can be set from a distance.

### 4.1 Settings for switching contact A «Light»

#### Potentiometer

##### ① **Brightness threshold “LUX”**

- Transfer zones (no working area)
- Bright transfer zones
- Deactivation of brightness measurement

Scale

approx. 2

approx. 4

“on”

Depending on the installation location, natural light intensity, furniture, reflection characteristics of the room and the furniture it may be necessary to correct the settings by 1-2 steps on the scale.

For ease of setting up, we recommend the service remote control QuickSet plus.

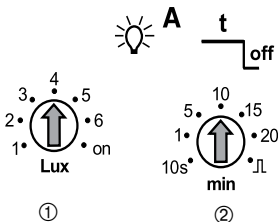

## ② Switch-off delay time

- Transfer areas approx. 5min.
- In the range between 2 - 15min the switch-off delay varies according to its self-learning behavior. The set values <2min or >15min remain fixed.
- $\perp$  «Pulse»: staircase lighting timer control (0.5s “on” / 10s “off”)

## DIP switch



## ③ Fully / Semi-automatic mode

- «auto»: Fully automatic mode. The lighting is switched on automatically.
- «man»: Semi-automatic mode. The lighting must be switched on manually.

## ④ Push-button function: room / corridor

- «room»: Manual switching on/off possible.
- «corridor»: Detector is used as staircase lighting timer. No manual switching-off possible.



## ⑤ Push-button/Switch control

- Optional push-button or switch operation.
- Multiple push-buttons on one control input possible.
- Use illuminated push-buttons with PEN conductor connection only.

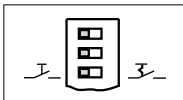



## 4.2 Settings for switching output B «Presence»

### ⑥ Switch-off delay time for presence

- The pre-set values remain unchanged (no self-learning effect).

### ⑦ Switch-on delay time for presence

- In case of presence, the contact does not close before the set switch-on delay has elapsed.
- 0 = Contact closes immediately in case of presence.
-  Room surveillance function; the contact closes only in case of distinct movements (effective protection against false alarms).

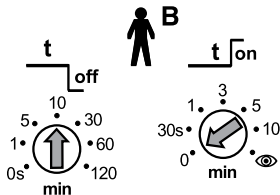

⑥

⑦

### **4.3 Behaviour on switching on**

Whenever the sensor module is plugged onto the power module or the unit is energised, the detector goes through three phases which are indicated by an LED.

#### 1. Start-up phase (30sec)

- LED flashes every second, both contacts are closed (light and presence on)
- In case of absence, both contacts open after 30sec.

#### 2. Service phase (10min)

- The «Light» contact reacts instantaneously on brightness in order to check the brightness threshold.
- If the brightness is insufficient the lighting is switched on (LED on), and if the brightness is sufficient the lighting is switched off (LED off).
- During the service phase, switching of the lighting occurs fully automatically (no semi-automatic mode).
- The service phase terminates earlier by actuating the push-button or the remote control.

#### 3. Operation

- The detector is ready for operation (LED off).

## 5. Additional wiring examples

### 5.1 Master-Slave parallel circuit operation

**Multiple** detectors control **one** lighting group

- Only the master switches the lighting. All other detectors serve as slaves.
- Presence detection is done by all detectors together.
- Light measurement occurs on the master only.
- Only set the potentiometer and DIP switches on the master.
- Max. 10 detectors can be connected in parallel.
- Use the same phase for all detectors.
- Mark the power modules as master or slave respectively.

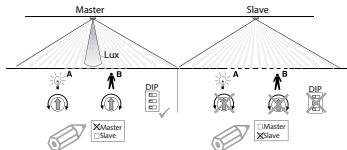
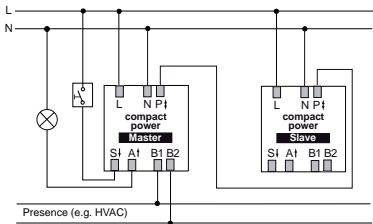

## 5.2 Master-Master parallel circuit operation

### Multiple masters control multiple lighting groups

- One master with individual brightness measurement per lighting group.
- Presence detection is done by all detectors together.
- Potentiometer and DIP switches are set on each master individually.
- Max. 10 detectors can be connected in parallel.
- Use the same phase for all detectors.
- The switching contact «Presence» can be tapped on any master.
- Mark the power modules as master or slave respectively.

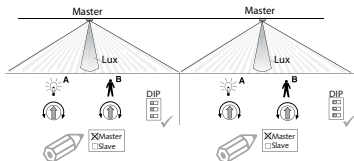
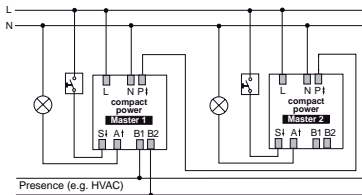

### 5.3 Parallel circuit operation with external staircase lighting timer

- Directly connect the switching contacts of multiple detectors in parallel.
- Set the switch-off delay on all detectors to “pulse”.
- Mark all power modules as master.
- Staircase lighting timer e.g. Theben ELPA 1

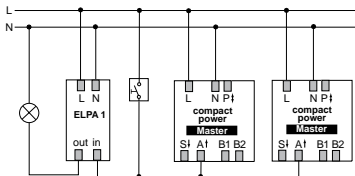

### 5.4 Detector as staircase lighting timer

- The master directly controls the lighting.
- The push-button starts the master's switch-off delay.
- Set DIP switch to “corridor” to prevent switching off via push-button.
- Further slaves can be connected in parallel using the P-terminal if required
- Only set the potentiometer and DIP switches on the master.
- Mark the power modules as master or slave respectively.

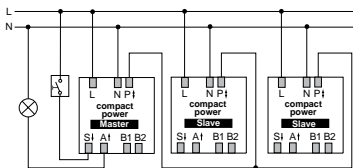

## 6. Test mode

The test mode serves to check the presence detection and the wiring (Master-Slave parallel circuit operation).



### 6.1 Setting the test mode with DIP-Switch

- Set DIP switch to «Test» (on all detectors in parallel circuit operation).

#### 1. Start-up phase (30sec)

- Both contacts are closed for 30sec. (LED 20s «on», 10s «off» )



#### 2. Test mode

- In case of movement (LED on), both contacts close.
- In case of absence (LED off), both contacts open after 10sec.
- NOTE: no brightness measurement, detector always in fully automatic mode.
- The detector remains permanently in the test mode.

### 6.2 Setting the test mode with QuickSet plus

- While setting the test mode with the service remote control QuickSet plus, the detector jumps the start-up phase and changes directly into the test mode.
- Test mode ceases automatically after 10 minutes. The detector performs a reset (see section 4.3).

## 7. Technical specifications

Sensor module		compact passage
Detection range	horizontal vertical	360° 160°
Recommended mounting height		2,0 - 3,5m
Maximum range		30 x 4 m (Mh. 2,5m) 30 x 5 m (Mh. 3,5m)
Mixed light measurement Light measurement deactivated		ca. 10 - 1500Lux „on“
Switch-off delay time for light Short pulse		10sec. - 20min. 0.5sec. „on“/ 10sec. „off“ 
Switch-off delay for „Presence“		10sec. - 120min.
Switch-on delay for „Presence“ Room surveillance		0sec. - 10min. 
Power module		compact power
Mains voltage		230V ± 10%, 50Hz
<b>Relais output A for «Light»</b>		<b>230V ± 10%</b>
In-line fuse		max. 10A
Max. switching capacity Incandescent lamps, halogen		1400VA 1200W
Max. nr. of electronic ballasts *) (A relay or contactor must be connected in case of more powerful devices)		10x (1x58W); 5x (2x58W) 16x (1x36W); 8x (2x36W) 16x (< 36W)

<b>Relais output B for «Presence»</b>	<b>potential-free</b>
Maximum voltage	220V DC / 250V AC
Maximale switching capacity	50W / 50VA
Recommended minimum load	0.5mV / 10mA
Depth	40mm
Diameter	48mm
Mounting place	70 x 70mm
Screw terminals	max. 2x 2.5mm <sup>2</sup>
Size of concealed housing	Size 1, (NIS,PMI)
Ambient temperature	0° - 50°C
Degree of protection	IP 40
<b>Article numbers</b>	
compact passage	201 0 090
Surface frame for compact	907 0 514
Service remote control QuickSet plus	907 0 532
User remote control clic	907 0 515

\*) Use of T5-FL: When using T5-FL lamps with a comparable wattage, the same number of electronic ballasts may be connected to the detector's switching contact as for the T8-FL. When using the 80W-FL, the number should be halved in comparison to the 58W-FL.

### CE Declaration of Conformity



This device complies with the protection regulations of the EMC directives 2004/108/EC and of the Low Voltage directive 2006/95/EC.



## 8. Warranty declaration

Theben HTS presence detectors are manufactured and quality-tested with the utmost care using state-of-the-art technologies. Theben HTS therefore guarantees perfect function, provided the detectors are used as intended. However, should a defect occur, Theben HTS offers the following warranty within the scope of its General Terms and Conditions of Business:

Please bear in mind the following points:

- The warranty period is 24 months, commencing from the manufacturing date.
- The warranty becomes null and void if you or third parties undertake alterations to the units.
- If the presence detector is connected to a software-controlled system, the warranty for this connection is only valid provided the stated interface specification is adhered to.

We undertake to repair or replace as quickly as possible all supplied components which have become defective or unusable as a result of demonstrably bad material, faulty design or defective workmanship up to the expiry of the warranty period.

### Returns

In the event of a warranty claim please send the unit together with the delivery note and a brief description of the fault to the dealer concerned.

### Industrial property rights

The concept including hardware and software of these units is protected by copyright.

## 9. Troubleshooting

Fault	Cause
Lighting does not switch on or switches off in case of presence and darkness	Lux value setting is too low; Detector is in semi-automatic mode; Lighting was switched off manually; Person is outside the detection range; Detection is disturbed by obstacle(s); Set switch-off delay setting is too short
With persons present, the lighting is on although the brightness is sufficient	Lux value setting is too high; The lighting has been switched on manually with clic recently (wait for 30 min); Detector is in test mode
Lighting does not switch off or switches on spontaneously in case of absence	Wait until the switch-off delay time has elapsed (self-learning effect); Disturbing heat sources within the detection range (heaters, incandescent lamp/halogen lamp, moving objects (e.g. curtains due to open windows); Load (el. starter devices, relay) has no interference suppression
Lighting keeps switching on and off during the service phase	Too much artificial light is falling on the detector. Increase lux value or reposition the detector.
Push-button does not work	Device is still in start-up phase or an illuminated push-button without PEN conductor connection is used; Push-button is not connected to the master
Lighting cannot be switched off with the push-button	DIP-switch in „corridor“ position
Device does not respond	Short circuit/ multiple phases connected in parallel! Disconnect detector from mains for 5 min. (thermal protection switch).
Error blinking (4x per sec.)	Failure during self test. Device not working!

## Dimensions compact passage

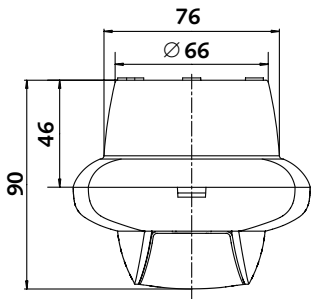
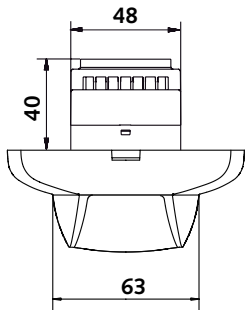
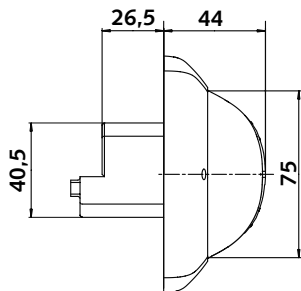
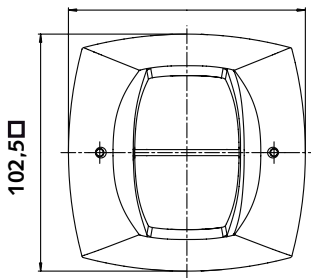

GB

Subject to change without prior notice. Errors and omissions excepted.

## **Theben AG**

Hohenbergstrasse 32, DE-72401 Haigerloch

Tel. +49 (0) 74 74 692 - 0

Fax +49 (0) 74 74 692 - 150

## **Hotline**

Tel. +49 (0) 74 74 692 - 369

Fax +49 (0) 74 74 692 - 207

hotline@theben.de

Switzerland

## **Theben HTS AG**

Im Langhag 11, CH - 8307 Effretikon

Tel. +41 (0)52 355 17 00

Fax +41 (0)52 355 17 01

[www.theben-hts.ch](http://www.theben-hts.ch)

Die Kontaktadressen für weitere Länder finden Sie auf [www.theben.de](http://www.theben.de)

Veuillez consulter les adresses pour des pays supplémentaires sur [www.theben.de](http://www.theben.de)

Please find the contact addresses for additional countries on [www.theben.de](http://www.theben.de)

Las direcciones de contacto de otros países las encontrará en [www.theben.de](http://www.theben.de)

Gli indirizzi per ulteriori paesi sono disponibili su [www.theben.de](http://www.theben.de)

De contactadressen voor andere landen vindt u op [www.theben.de](http://www.theben.de)