

The ETU2000 and ETU8000 provide economical and convenient control of immersion heaters. They have a permanent OFF control for holidays and when alternative heating is available. The products are designed primarily for retrofit part way along the flying lead to an immersion heater from a switched connection unit, but also have knock outs to accept rear entry cables. The ON status is indicated by a light emitting diode (L.E.D.) - helpful in dark locations.

The ETU8000 is a 7 day timeswitch with up to 6 programmable ON periods each allocatable over all 7 days, 5 weekdays, 2 weekend days and individual days. It has an override but no boost feature.

The ETU2000 is a 24 hour Immersion Heater Timeswitch with up to 4 programmable ON periods per day. It has the capability to give 1 or 2 hours boost at the push of a button.

Installation should be carried out by a competent DIY person. If in doubt consult a qualified electrician.

Installation

1. Locate unit on a flat surface between switched supply and load. The location chosen should be accessible enough to enable clock adjustment and re-programming.

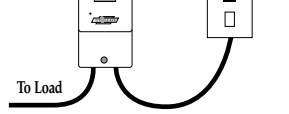

The local switch shown above (because it is usually present in retrofit situations) is not necessary to meet the IEE wiring regulations. The switch on your consumer unit or switch-fuse gives adequate isolation.

2. Remove terminal cover screw and terminal cover.

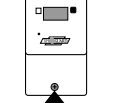

3. Place unit in required position and mark the wall at the centre of the top side.

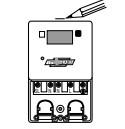

4. Measure down from this mark 16.5mm and make a second mark. At this second mark drill a hole and fit a wall plug suitable for a No. 6 woodscrew. (Screw and plug not supplied.)

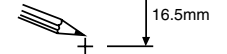

5. Screw home and leave head of woodscrew proud as shown.

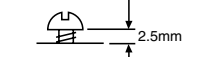

6. Place the keyhole slot (in back of unit) over the screw head and pull the unit downwards. Align the unit vertically and mark the wall through the recessed hole in the bottom of the unit.

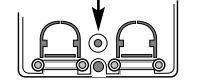

7. Remove the unit and at this third mark drill and plug as before.

8a. For Bottom Cable Entry
Replace the unit over the first screw head and screw home the second screw through the recessed hole.

8b. For Rear Entry Cable
Carefully remove knock-outs from the rear of the unit and use the knock-outs to block off the bottom cable entry holes.

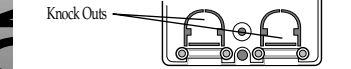

Knock-outs slide into bottom cable entry holes.

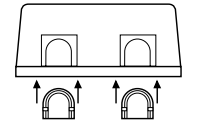

If required only one knock-out can be removed giving rear cable entry and bottom cable exit.

Fix the unit to the wall as in 8a above after guiding cable tails through the knockouts.

Wiring

Switch off/isolate mains electricity supply.

Wire in accordance with the cable plan below.

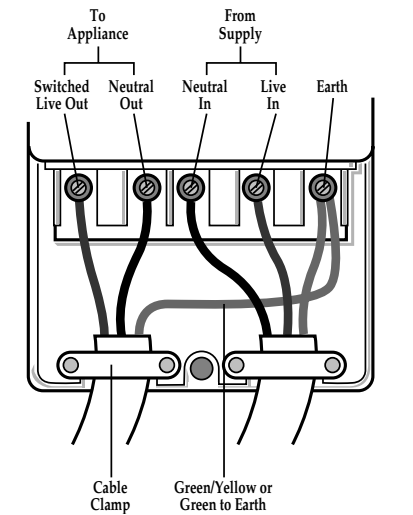

For bottom cable entry use the cable clamps provided to grip the cable outer and provide strain relief.

Important: Earth continuity must be maintained, connect cable earths to the earth terminal marked

Circuit Diagram

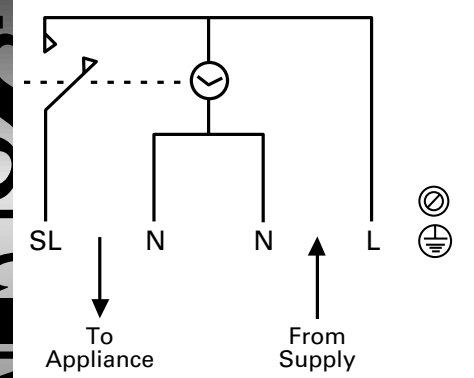

ETU2000 Programming Instructions

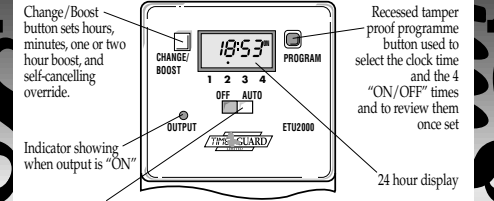

OFF/AUTO switch giving continuous OFF or timed operation in AUTO

Battery

This product has a factory fitted rechargeable battery. If the ETU2000 is left with its mains power switched off for more than 1 month the display may go blank. In this case, switch mains on, wait 30 minutes, and apply reset - see 1 before programming.

Programming

Only two setting buttons are required, <Change> and <Program>. The <Program> button is recessed to prevent inadvertent programme change and requires a pen or similar implement to operate it. In normal use the <Change> button is used to switch ON or OFF, overriding the timeswitch until the next programmed OFF or ON time. During programming the <Change> button is used to set the hours and minutes. The <Program> button is used to select the clock time or the 4 programmed ON/OFF times and to review them once they have been set. Each time the <Program> button is pressed the display will flash either the hours or minutes in turn, starting with the clock then the first ON time, first OFF time, second ON time etc. Wherever the hours or minutes are flashing they may be set using the <Change> button. Once set the <Program> button is pressed again to proceed to the next stage.

Normal Operating Mode

In normal operation the unit will display the correct time with the colon flashing. The output status will be shown by either ON or OFF on the display.

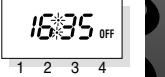

1 To Reset Before Programming

(To alter clock time or modify programmes - see section 5)

To clear programmes from memory and reset the ETU2000 press and hold down both buttons until the display goes blank. Release buttons and display will fill with its complete range of characters and then clear to show clock and hour digit flashing. This procedure is essential with a new ETU2000 and is recommended if major reprogramming is required subsequently.



You are now in the clock setting mode at the beginning of the programme sequence

Programming sequence

Setting clock→	Programme 3 ON
Programme 1 ON	Programme 3 OFF
Programme 1 OFF	Programme 4 ON
Programme 2 ON	Programme 4 OFF
Programme 2 OFF	Operating Mode

Note: Pauses between button presses greater than 1 minute during programming will result in automatic return to the operating mode.

2 Setting Clock (after reset)

i Hour Setting - Press the <Change> button to advance the hour setting. For rapid hour selections press and hold down <Change> button.



ii Minute Setting - Press the <Program> button briefly to select the minutes - display shows clock symbol and minute digits flashing. Press the <Change> button to advance the minutes setting. For rapid minute selection press and hold down <Change> button. (Note: 16 hours shown as example of hours set)



iii Press <Program> button briefly - clock is now set and display shows ready for the first programme ON time with ON and hours digits flashing.

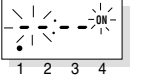

3. To Set Programme ON/OFF Times (after clock setting)

i Press <Change> button to advance the hour setting for the first programme ON time.

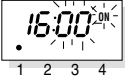

ii Press <Program> button briefly to select minutes - display shows minute digits and ON flashing. Press <Change> button to advance minutes setting. (Note: 16 hours shown as example of hours set).

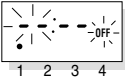

iii Press <Program> button briefly - the first ON time is now set and display shows ready for the first OFF programme time.

iv Now set the hours and minutes as before.

v Repeat steps i to iv to set the remainder of the 3 programme ON/OFF times as required. Note: Any unused ON/OFF programmes must be left blank and should be skipped by pressing the <Program> button until the display shows normal operating mode. Do not programme '0's into unused programmes.

IMPORTANT After setting a clock time which falls within a programmed ON period, the unit will not switch ON. Press the <Change> button to switch the ETU2000 ON. After this the unit will operate normally to the programmes set.

4. Programme Review

To fast review the set programmes or for quick exit to normal operating mode - press and hold down the <Program> button. Normal review can be carried out by pressing the <Program> button briefly which reviews the clock time with the whole display flashing. Further brief pressing of this button reviews the programme ON and OFF times in sequence again with the whole display flashing.

5. Initiating Programme Mode

This is required when making changes to the clock time or programme times and can be initiated any time during the normal operating mode. Press the <Program> button briefly and the clock symbol, hours and minutes symbols on the display will flash - this is review mode. Further brief pressing of the <Program> button will display the ON and OFF programmes in sequence. Having reached the clock or programme time requiring change, press the <Change> button briefly to initiate programme mode and then follow steps 2 and 3 as required. Having completed the change press and hold down the <Program> button until normal operating mode is reached and then release.

HELPLINE
020-8450-0515



For a product brochure please contact:
Timeguard Ltd.
Victory Park, 400 Edgware Road,
London NW2 6ND
020-8452-1112
or email csc@timeguard.com

Designed and manufactured in the U.K. 67-058-62 (ISS 2)

9
10
11
12
13
14

6. Cancelling Programmes
Any ON/OFF programme can be cancelled by clearing its ON and OFF time. Follow step 5 and when into the ON or OFF programme to be cancelled press the <Change> button until the hour digits show --:-- then press the <Program> button briefly to clear the programme. The display will show the hour and minute dashes and ON or OFF flashing. (Note: Programme 1 shown as an example of programme previously set.)

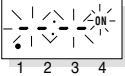

7. Programming Across Midnight
The ETU2000 can programme across midnight without any special precautions.

8. Boost and Self-Cancelling Override
The ETU2000 has the facility at the press of a button to give one or two hours boost when the temperature of the hot water in the tank has fallen to an unacceptable level. This is available from normal running mode in AUTO only by pressing the <Change/Boost> button. Press once for 1 hours boost and twice for 2 hours boost. This will immediately turn the output ON for the duration of the boost selected and show either "1 hr" or "2 hr" on the display.

By pressing the button for a third time the current state of programme is overridden until the next programmed change (e.g. if the unit is ON it turns OFF, remaining OFF when the programmed OFF time is reached).

By pressing the button for a fourth time normal timed operation is restored. If it is found that after say 2 hours boost has been selected the water is sufficiently hot before that time has elapsed simply press the <Change/Boost> button twice to

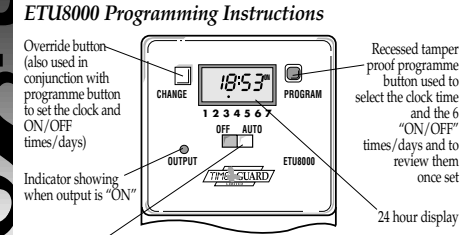

Battery
This product has a factory fitted rechargeable battery. If the ETU8000 is left with its mains power switched off for more than 1 month the display may go blank. In this case switch mains on, wait 30 minutes, and apply reset - see 1 before programming.

Programming
This is a seven day (weekly) timeswitch which has six programmes, each of which can be block programmed to work on all of the five weekdays, both weekend days, or all 7 days (24 hour operation). Programmes can also be designated to operate on individual days. Only two setting buttons are required, <Change> and <Program>. The <Program> button is recessed to prevent inadvertent programme change and requires a pen or similar implement to operate it. In normal use the <Change> button is used to switch ON or OFF, overriding the timeswitch until the next programmed OFF or ON time. During programming the <Change> button is used to set the hours, minutes and days. The <Program> button is used to select the clock time and day or the 6 programmed ON/OFF times and days and to review them once they have been set. Each time the <Program> button is pressed the display will flash either the days, hours or minutes in turn, starting with the clock time and day then the first ON time and day(s), first OFF time, second ON time and day(s) etc. Wherever the days, hours or minutes are flashing they may be set using the <Change> button. Once set the <Program> button is pressed again to proceed to the next stage.

Normal Operating Mode
In normal operation the ETU8000 will display the correct day and its time with the colon flashing. The output status will be shown by either ON or OFF on the display.



1 To Reset Before Programming
(To alter clock time or modify programmes - see section 5)
To clear programmes from memory and reset the ETU8000 press and hold down both buttons until the display goes blank. Release buttons and display will fill with its complete range of characters and then clear to show clock and day 1 symbol flashing. This procedure is essential with a new ETU8000 and is recommended if major reprogramming is required subsequently.



You are now in the clock setting mode at the beginning of the programme sequence

Programming sequence

Setting clock→	Programme 4 ON
Programme 1 ON→	Programme 4 OFF
Programme 1 OFF→	Programme 5 ON
Programme 2 ON→	Programme 5 OFF
Programme 2 OFF→	Programme 6 ON
Programme 3 ON→	Programme 6 OFF
Programme 3 OFF→	Operation Mode

Note: Pauses between button presses greater than 1 minute during programming will result in automatic return to the operating mode.

2 Setting Clock (after reset)
i **Day Setting** - Press <Change> button to advance to the day required. Day 1 = Monday and Day 7 = Sunday.



ii **Hour Setting** - Press the <Program> button briefly to select the hours - display shows clock symbol and the hours digits flashing.

Press the <Change> button to advance the hour setting. For rapid hours selection press and hold down <Change> button. (Note: Monday shown as example of day set.)

iii **Minute Setting** - Press the <Program> button briefly to select the minutes - display shows clock symbol and minute digits flashing. Press the <Change> button to advance the minutes setting. For rapid minute selection press and hold down <Change> button. (Note: 16 hours shown as example of hours set)



iv Press <Program> button briefly - clock is now set and display shows ready for the first ON programme time.



3. To Set Programme ON/OFF Times (after clock setting)

i The user is now able to set the day(s) that the first programme will operate on. The alternatives are:

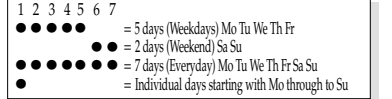

Initially dots 1 to 5 flash indicating that if this option were selected, the programme times about to be entered would operate over the five weekdays. If another option is required, the <change> button should be pressed until the correct day(s) flash.

ii Once the day option has been selected press <Program> button briefly to select hour time - display shows hour digits and ON flashing. Press <Change> button to advance hour setting. (Note: 2 days (Sat & Sun) shown as examples of days set.)

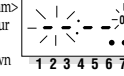

iii Press <Program> button briefly to select minutes - display shows minute digits and ON flashing. Press <Change> button to advance minute setting. (Note: 16 hours shown as example of hours set.)



iv Press <Program> button briefly - the first ON time is now set and display shows ready for the first OFF programme time.

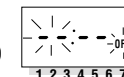

v Now set the hours and minutes as before. The day(s) selected remains the same.

vi Repeat steps i to v to set the remainder of the 5 programme ON/OFF times and day(s) as required. Note: Any unused ON/OFF programmes must be left blank and should be skipped by pressing the <Programme> button until the display shows normal operating mode. Do not programme '0's into unused programmes.

4. Programme Review
To fast review the set programmes or for quick exit to normal operating mode - press and hold down the <Program> button. Normal review can be carried out by pressing the <Program> button briefly which reviews the clock time and day with the whole display flashing. Further brief pressing of this button reviews the programme ON and OFF times and day(s) in sequence again with the whole display flashing.

5. Initiating Programme Mode
This is required when making changes to the clock time/day or programme times/days and can be initiated any time during the normal operating mode. Press the <Program> button briefly and the clock symbol, day flag, hrs and minutes symbols on the display will flash - this is review mode. Further brief pressing of the <Program> button will display the ON and OFF programmes in sequence. Having reached the clock time/day or programme time/day(s) requiring change, press the <Change> button briefly to initiate programme mode and then follow steps 2 and 3 as required. Having completed the change press and hold down the <Program> button until normal operating mode is reached and then release.

6. Cancelling Programmes
Any ON/OFF programme can be cancelled by clearing its ON and OFF time. Follow step 5 and when into the ON and OFF programme to be cancelled press the <Change> button briefly and the day dot(s) will flash, press the <Program> button briefly to select the hours and then press the <Change> button until the hour digits show --:-- then press the <Program> button briefly to clear the programme. The display will show the hour and minute dashes and ON or OFF flashing.

Programming Across Midnight
This can be achieved by programming the required ON time in the initial day and the required OFF time in the subsequent day. The unused times in these two programmes can either be left blank (---) or used for an OFF time during the initial day and an ON time during the subsequent day.

Self Cancelling Override
To change the output status from ON to OFF or vice versa press the <Change> button. The output status will change and indicate override is in operation by flashing either the ON or OFF symbol on the display. The override will end at the next programmed change, or sooner, if the <Change> button is pressed again.

Specifications

1. Conforms to Directives:	73/23/EEC & 89/336/EEC.
2. Control Type:	1B.
3. Contacts:	Silver Cadmium Oxide, single pole normally open.
4. Permissible Loads:	13A Resistive (3kW) 6A At 0.4 power factor inductive. 2400W Filament lamps. 500W Fluorescent lighting with or without power factor correction capacitors (4µF per 65W tube). 1 h.p. Motor. 1000 hours by factory fitted rechargeable battery.
5. Battery Back-up:	1000 hours by factory fitted rechargeable battery.
6. Operating Ambient Temperature Range:	-10°C to 50°C.
7. Operating Voltage:	220 - 240V AC.

Not suitable for discharge lighting (e.g. SON and Metal Halide)

3 Year Guarantee
In the unlikely event of this product becoming faulty, due to defective material or manufacture, within 3 years of the date of purchase, please return it to your supplier with proof of purchase and it will be replaced free of charge.

Should you encounter any difficulty please contact our helpline on 020 8450 0515.

**ELECTRONIC
IMMERSION HEATER
TIMESWITCH**
Cat No. ETU2000 (24 Hour)
Cat No. ETU8000 (7 Day)



INSTALLATION & OPERATING INSTRUCTIONS